

LAHP

SUPER-HIGH TEMPERATURE WATER TO WATER HEAT PUMPS



TECHNICAL MANUAL

Incorporated in this document are the following:

- Declaration of conformity
- Technical manual

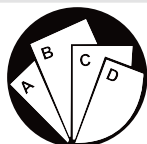

Multiple instructions:
Consult the specific part



Read and understand the
instructions before underta-
king any work on the unit

RETAIN FOR FUTURE REFERENCE

Reproduction, data storage and transmission, even partial, of this publication, in any form, without the prior written authorisation of the Company, is prohibited. The Company can be contacted for all inquiries regarding the use of its products.

The Company follows a policy of continuous product development and improvement and reserves the right to modify specifications, equipment and instructions regarding use and maintenance at any time, without notice.

Declaration of conformity

We declare under our own responsibility that the below equipment complies in all parts with the CEE and EN directives.

The declaration of conformity is enclosed to the technical booklet enclosed with the unit. The unit contains fluorinated greenhouse gases.

INDEX

1. INTRODUCTION	5
1.1 Preliminary information	5
1.2 Aim and content of the manual	5
1.3 How to store this manual	5
1.4 Manual updates	5
1.5 How to use this manual	5
1.6 Potential risks	6
1.7 General description of symbols used	7
1.8 Safety symbols used	8
1.9 Limitations and prohibited use	9
1.10 Unit identification	9
2. SAFETY	10
2.1 Warning re potentially hazardous toxic substances	10
2.2 Refrigerant handling	10
2.3 Prevention of inhalation of high vapor concentrations	11
2.4 Procedures in the event of accidental release of refrigerant	11
2.5 Main Toxicological information on the type of refrigerant used	11
2.6 First aid measures	11
3. TECHNICAL CHARACTERISTICS	12
3.1 Unit description	12
3.2 Other versions	13
3.3 Accessories description	14
3.4 Technical data	15
3.5 Operation limits	16
3.6 Compressor capacity steps	17
3.7 Correction tables	17
3.8 Sound data	18
4. INSTALLATION	19
4.1 General safety guidelines and use of symbols	19
4.2 Workers' health and safety	19
4.3 Personal protective equipment	19
4.4 Inspection	20
4.5 Storage	20
4.6 Unpacking	20
4.7 Lifting and handling	21
4.8 Location and minimum technical clearances	21
4.9 Installation of rubber vibration dampers (KAVG)	23
4.10 Serial interface card RS485 (INSE)	23
4.11 Source water pump installation	24
4.12 Hydraulic connections	24
4.13 Chemical characteristics of the water	25
4.14 User circuit minimum water content	25
4.15 Installation with source open circuit (heat pump water water)	26
4.16 Chemical characteristics of source water circuit	26
4.17 Hydraulic components	27
4.18 Domestic hot water (dhw) hydraulic circuit	31
4.19 Filling the hydraulic circuit	31
4.20 Emptying the installation	31
4.21 Wiring connections: Preliminary safety information	32
4.22 Electric data	33
4.23 Electric connections	34
4.24 Positioning of the user circuit water inlet sensor (bti)	36
4.25 Positioning of the domestic hot water circuit sensor (bts)	36
4.26 Refrigerant circuit layout	37

5. UNIT START UP	38
5.1 Preliminary Checks	38
5.2 Position of the control panel	40
5.3 Description of the control panel	40
5.4 To remote the control	41
6. USE	43
6.1 Switch the unit on	43
6.2 Stop	44
6.3 Set points	45
6.4 PROBES key	46
6.5 ALARM key	46
6.6 CIRC key	47
6.7 SERVICE key	49
6.8 Acoustic signal silencing	61
6.9 Emergency Stop	61
7. MAINTENANCE OF THE UNIT	62
7.1 General warnings	62
7.2 Access to the unit	62
7.3 Scheduled maintenance	63
7.4 Periodical checks	63
7.5 Refrigerant circuit repair	65
8. DECOMMISSIONING	66
8.1 Unit Isolation & drain down	66
8.2 Disposal, recovery and recycling	66
8.3 RAEE directive (only for EC countries)	66
9. DIAGNOSIS & TROUBLESHOOTING	67
9.1 Fault finding	67

1. INTRODUCTION

1.1 Preliminary information

Reproduction, storage or transmission of any part of this publication in any form, without the prior written consent of the Company, is prohibited.

The unit to which these instructions refer, is designed to be used for the the purposes described and to be operated in accordance with these instructions.

The Company will not be liable for claims for damage caused to persons, animals, material goods or property caused by improper installation, adjustment and maintenance or improper use. Any use not specified in this manual is prohibited.

This document is intended to provide information only and does not form a contract with third parties.

The Company pursues a policy of constant improvement and development of its products and therefore reserves the right to change the specifications and the documentation at any time, without notice and without obligation to update existing equipment.

1.2 Aim and content of the manual

These instructions are intended to provide the information required for the selection, installation, use and maintenance of the unit.

They have been prepared in accordance with the European Union laws and with the technical standards in force at the date of issue of the instructions.

The instructions contain all the necessary information to prevent any reasonably foreseeable misuse.

1.3 How to store this manual

The manual must be kept in a suitable place with easy access for users and operators, protected from dust and damp.

The manual must always accompany the unit during the entire life cycle of the same and therefore must be transferred to any subsequent user.

1.4 Manual Update

It is recommended that the manual is updated to the latest revision available.

If updates are sent to the customer they must be added to this manual.

The latest information regarding the use of its products is available by contacting the Company.

1.5 How to use this manual



The manual is an integral part of the unit.

Users or operators must consult the manual before performing any operation and especially so when transporting, handling, installing, maintaining, or dismantling the unit in order to eliminate uncertainty and reduce risk.



In these instructions symbols have been used (described in the following paragraphs) to draw the attention of operators and users to the operations that have a higher risk and which must be performed safely.

1.6 Potential Risks

Whilst the unit has been designed to minimize any risk posed to the safety of people who will interact with it, it has not been technically possible to eliminate completely the causes of risk. It is therefore necessary to refer to the requirements and symbolism below:

LOCATION OF RISK	POTENTIAL RISK	METHOD OF INJURY	PRECAUTIONS
Thermal heat exchangers.	Small stab wounds.	Contact	Avoid any contact, use protective gloves.
Fan and fan grilles.	Cuts, eye damage, broken bones.	Insertion of sharp objects through the grid while the fans are operating.	Never put objects through the protection grilles.
Internal component: compressors and discharge pipes	Burns.	Contact	Avoid any contact, use protective gloves.
Internal component: electric cables and metallic parts	Electrocution, severe burns.	Defect in the supply cable insulation, live metallic parts.	Adequate protection of power cables, ensure correct earthing of all metal parts.
External to unit: unit enclosure	Poisoning, severe burns.	Fire due to short circuit or overheating of the supply cable external to unit.	Size cables and mains protection system in accordance with iee regulations.
Low pressure safety valve.	Poisoning, severe burns.	High evaporating pressure causing a refrigerant discharge during maintenance.	Carefully check the evaporating pressure during the maintenance operations. Use all personal protective equipment required by the law. PPE must also protect against gas leaks from the safety valve. The outlet of these valves is directed to avoid causing damage to persons or goods.
High pressure safety valve.	Poisoning, severe burns, hearing loss.	Activation of the high pressure safety valve with the refrigerant circuit open.	If possible, do not open the refrigerant circuit valve; carefully check the condensing pressure; use all the personal protective equipment required by law. PPE must also protect against gas leaks from the safety valve. The outlet of these valves is directed to avoid causing damage to persons or goods.
Entire unit	External fire	Fire due to natural disasters or combustions of elements nearby unit	Provide the necessary fire-fighting equipment
Entire unit	Explosion, injuries, burns, poisoning, folgoramento for natural disasters or earthquake.	Breakages, failures due to natural disasters or earthquake	Plan the necessary precautions both electrical (suitable differential magneto and electrical protection of the supply lines; greatest care during the connections of the metal parts), and mechanical (special anchors or seismic vibrations to prevent breakages or accidental falls).

1.7 General Description of Symbols Used

Safety symbols combined in accordance with ISO 3864-2:



BANNED

A black symbol inside a red circle with a red diagonal indicates an action that should not be performed.



WARNING

A black graphic symbol added to a yellow triangle with black edges indicates danger.



ACTION REQUIRED

A white symbol inserted in a blue circle indicates an action that must be done to avoid a risk.

Safety symbols combined in accordance with ISO 3864-2:



The graphic symbol “warning” is qualified with additional safety information (text or other symbols).

1.8 Safety symbols used



GENERAL RISK

Observe all signs placed next to the pictogram. The failure to follow directions may create a risk situation that may be injurious to the user.



ELECTRICAL HAZARD

Observe all signs placed next to the pictogram.

The symbol indicates components of the unit and actions described in this manual that could create an electrical hazard.



MOVING PARTS

The symbol indicates those moving parts of the unit that could create risk.



HOT SURFACES

The symbol indicates those components with high surface temperature that could create risks.



SHARP SURFACES

The symbol indicates components or parts that could cause stab wounds.



EARTH CONNECTION

The symbol identifies Earthing connection points in the unit.



READ AND UNDERSTAND THE INSTRUCTIONS

Read and understand the instructions of the machine before any operations.



RECOVER OR RECYCLE MATERIAL

1.9 Limitations and prohibited use

The machine is designed and built exclusively for the uses described in "Limitations of use" of the technical manual. Any other use is prohibited because it may pose a potential risk to the health of operators and users.



The unit is not suitable for operations in environments:

- excessively dusty or potentially explosive atmospheres;
- where there are vibrations;
- where there are electromagnetic fields;
- where there are aggressive atmospheres



1.10 Unit identification

Each unit has a rating plate that provides key information regarding the machine.

The rating plate may differ from the one shown below as the example is for a standard unit without accessories.

For all electrical information not provided on the label, refer to the wiring diagram.

A facsimile of the label is shown below:

 <small>Manufacturer: PD322111</small>		 1370	
LAHP 2604WW		123456	
<small>Pompa di calore Heat pump</small>		<small>Matricola Serial number</small>	
2		5/2018	
<small>Categoria PED PED Category</small>		<small>Data di produzione Manufacturing date</small>	
R410A	2	2088	
<small>Tipo refrigerante Refrigerant type</small>	<small>Gruppo fluido Fluid group</small>	<small>GWP</small>	
C1 19 kg	C2 19 kg	79,34 ton	
<small>c3</small>	<small>c4</small>	<small>CO₂ Equivalente CO₂ Equivalent</small>	
<small>Carica refrigerante Refrigerant charge</small>		<small>CO₂ Equivalente CO₂ Equivalent</small>	
400V-3ph-50Hz		162,20 A	110,20 kW
<small>Tensione-Fasi-Frequenza Voltage-Phases-Frequency</small>		<small>F.L.A. (A)</small>	<small>F.L.I. (kW)</small>
<small>LATO BASSA PRESSIONE LOW PRESSURE SIDE</small>		<small>LATO ALTA PRESSIONE HIGH PRESSURE SIDE</small>	
29,5 bar		45 bar	
<small>PS</small>		<small>PS</small>	
<small>Min</small>	<small>Max</small>	<small>Min</small>	<small>Max</small>
-30 °C	+130 °C	-30 °C	+130 °C
<small>Temperatura di progetto Design temperature</small>		<small>Temperatura di progetto Design temperature</small>	
<small>Peso a vuoto Weight</small>		 229137	
<small>Barcode</small>			
<small>Contiene gas fluorurati ad effetto serra. Contains fluorinated greenhouse gasses.</small>			



The product label should never be removed from the unit.

2. SAFETY

2.1 Warning re potentially hazardous toxic substances

2.1.1 Identification of the Type of Refrigerant Fluid Used: R134a

- 1,1,1,2 – Tetrafluoroethane (HFC134a) 100% by weight CAS No.: 000811-97-2

2.1.2 Identification of the Type of Oil Used.

The lubricant used is polyester oil. Please refer to the information provided on the compressor data plate.



For further information regarding the characteristics of the refrigerant and oil used, refer to the safety data sheets available from the refrigerant and oil manufacturers.

Main Ecological Information Regarding the Types of refrigerants Fluids used.



ENVIRONMENTAL PROTECTION : Read the ecological information and the following instructions carefully.

2.1.3 Persistence and degradation

The refrigerants used decompose in the lower atmosphere (troposphere) relatively quickly. The decomposed products are highly dispersible and therefore have a very low concentration. They do not influence the photochemical smog which is not among the VOC volatile organic compounds (as stipulated in the guidelines to the UNECE). The constituent refrigerants of R407C (R32, R125 and R134a), do not damage the ozone layer. These substances are regulated under the Montreal Protocol (revised 1992) and regulations EC no. 2037/200 of 29 June 2000.

2.1.4 Effects of discharges

Discharges into the atmosphere of this product does not cause a long-term contamination.

2.1.5 Exposure controls and personal protection

Wear protective clothing and gloves, protect your eyes and face

2.1.6 Professional exposure limits

R134a	
HFC134a	TWA 1000 ppm

2.2 Refrigerant handling



Users and maintenance personnel must be adequately informed about the possible risks of handling potentially toxic substances. Failure to follow such instructions can cause damage to personnel or to the unit.

2.3 Prevent inhalation of high vapor concentration

Atmospheric concentrations of refrigerant must be minimized and kept to a level that is below the occupational exposure limit. Vapor is heavier than air and can form dangerous concentrations near the ground where the ventilation rate is lower. Always ensure adequate ventilation. Avoid contact with open flames and hot surfaces as this can cause toxic and irritating decomposition products to form. Avoid contact between liquid refrigerant and the eyes or skin.

2.4 Procedures to be adopted in the event of accidental release of refrigerant

Ensure suitable personal protection (especially respiratory protection) during cleaning operations.

If deemed safe, isolate the source of the leak. If the leakage is small and if adequate ventilation is provided, allow the refrigerant to evaporate. If the loss is substantial ensure that measures are taken to adequately ventilate the area.

Contain spilled material with sand, earth or other suitable absorbent material.

Do not allow the refrigerant to enter drains, sewers or basements, as pockets of vapor can form.

2.5 Main Toxicological Information Regarding the Type of refrigerant used

2.5.1 Inhalation

A high atmospheric concentration can cause anaesthetic effects with possible loss of consciousness. Prolonged exposure may lead to irregular heartbeat and cause sudden death. Higher concentrations may cause asphyxia due to the reduced oxygen content in the atmosphere.

2.5.2 Contact with skin

Splashes of nebulous liquid can produce frostbite. Probably not hazardous if absorbed through the skin. Repeated or prolonged contact may remove the skin's natural oils, with consequent dryness, cracking and dermatitis.

2.5.3 Contact with eyes

Splashes of liquid may cause frostbite.

2.5.4 Ingestion

While highly improbable, may produce frostbite.

2.6 First Aid Measures



Adhere scrupulously to the warnings and first aid procedures indicated below.

2.6.1 Inhalation

Move the person away from the source of exposure, keep him/her warm and let him/her rest. Administer oxygen if necessary. Attempt artificial respiration if breathing has stopped or shows signs of stopping. If the heart stops, perform external heart massage. Seek medical assistance.

2.6.2 Contact with skin

In case of contact with skin, wash immediately with lukewarm water. Thaw tissue using water. Remove contaminated clothing. Clothing may stick to the skin in case of frostbite. If irritation, swelling or blisters appear, seek medical assistance.

2.6.3 Contact with eyes

Rinse immediately using an eyewash or clean water, keeping eyelids open, for at least ten minutes. Seek medical assistance.

2.6.4 Ingestion

Do not induce vomiting. If the injured person is conscious, rinse his/her mouth with water and make him/her drink 200-300ml of water. Seek immediate medical assistance.

2.6.5 Further medical treatment

Treat symptoms and carry out support therapy as indicated. Do not administer adrenaline or similar sympathomimetic drugs following exposure, due to the risk of cardiac arrhythmia.

3. TECHNICAL CHARACTERISTICS

3.1 Unit description

WHK heat pumps are particularly suitable for applications that use source energy at medium or high temperatures.

These units have been designed to produce water at high or very high temperature for applications where it is necessary to have maximum efficiency in heating. The units are available in heating only mode and can produce water up to 78°C (HT version). A wide range of accessories allows you to choose the optimal solution.

3.1.1 Frame

All units are made from hot-galvanised sheet steel, painted with polyurethane powder enamel and stoved at 180°C to provide maximum protection against corrosion. The frame is self-supporting with removable panels. All screws and rivets used are made from stainless steel. The standard colour of the units is RAL 9018.

3.1.2 Refrigerant circuit

The refrigerant utilised is R134a. The refrigerant circuit is assembled using internationally recognised brand name components with all brazing and welding being performed in accordance with ISO 97/23. Each refrigerant circuit is totally independent from the other with the result that any fault or alarm condition on one circuit does not influence the other.

The refrigerant circuit includes: sight glass, filter drier, thermal expansion valve with external equalizer, Schrader valves for maintenance and control and pressure safety device (for compliance with PED regulations).

3.1.3 Compressors

The compressors used are a high performance scroll type that incorporates a special scroll design which enhances the efficiency of the refrigerant cycle when the source temperature is low. The compressors are all supplied with a crankcase heater and thermal overload protection by a klixon embedded in the motor winding. They are mounted in a separate enclosure thus enabling them to be maintained even if the unit is operating. Access to this enclosure is via the front panel of the unit. The crankcase heater is always powered when the compressor is in stand-by.

3.1.4 Source heat exchanger

Source heat exchanger are braze-welded plates and are made of stainless steel AISI 316.

The use of this type of exchangers greatly reduces the refrigerant charge of the unit compared to the conventional shell and tube evaporators, and increases the efficiency of the refrigerant loads. The heat exchangers are factory insulated with flexible close cell material and are protected by a temperature sensor used as antifreeze protection kit.

3.1.5 User exchangers

The user side heat exchanger is a braze welded, plate type heat exchanger, manufactured from AISI 316 stainless steel.

All units are supplied with a sub-cooler to enhance the performance of the refrigerant cycle. The user heat exchangers are factory insulated with flexible close cell material.

3.1.6 Electric enclosure

The enclosure is manufactured in order to comply with the requirements of the electromagnetic compatibility standards CEE EN60204. Access to the enclosure is achieved by removing the front panel of the unit. The following components are supplied as standard on all units: main switch, thermal overloads (protection of pumps and fans), compressor fuses, control circuit automatic breakers, compressor contactors, fan contactors and pump contactors. The terminal board has volt free contacts for remote ON-OFF, Summer/Winter change over (reversible type only) and general alarm. For all three phase units, a sequence relay that disables the power supply in the event that the phase sequence is incorrect (scroll compressors can be damaged if they rotate in the wrong direction), is fitted as standard.

3.1.7 Microprocessors

All units are supplied as standard with microprocessor controls. The microprocessor controls the following functions:

control of the water temperature, antifreeze protection, compressor timing, compressor automatic starting sequence, alarm reset, volt free contact for remote general alarm, alarms and operation LED's. If required (available as an option), the microprocessor can be configured in order for it to connect to a site BMS system thus enabling remote control and management. The technical department can discuss and evaluate, in conjunction with the customer, solutions using MODBUS protocols.

3.1.8 Control and protection devices

All units are supplied with the following control and protection devices: Return and supply user heat exchanger sensors, return and supply source heat exchanger sensors, high pressure switch with manual reset, low pressure switch with automatic reset, high pressure safety valve, compressor thermal overload protection, pump thermal overload protection (when present), source heat exchanger flow switch.

3.1.9 User flow switch

The flow utility is provided on all units and disables the operation of the unit in case of abnormal water flow in the system. The flow switch is made of a blade system fitted in the flow of the water; it is combined with two permanent magnets that assess the amount of water in transit and, in function of the measured parameter, enable or not the operation of the single-circuit units. The flow switch is mounted on a pipe section that the installer must connect to the inlet section of the exchanger before starting the unit.

3.2 Other versions

3.2.1 HH

This version is equipped with special compressors that allow the cooling circuit to manage high source water temperature with the consequent possibility of producing very high water temperatures on the user side up to 70°C.

3.2.2 HH/HT

This version is equipped with special compressors that allow the cooling circuit to manage high source water temperature with the consequent possibility of producing very high water temperatures on the user side up to 78°C.

3.2.3 HH/LT

This version is equipped with special compressors that allow the cooling circuit to manage medium source water temperature, up to 20°C, with the consequent possibility of producing high water temperatures on the user side up to 68°C.

3.2.4 Version LS (only units 1804 ÷ 2604)

This version includes the complete acoustic insulation of the unit with compressor jackets and insulating material made with high density media and the interposition of heavy bitumen layer.

3.2.5 XL Super low noise version (only units 312 ÷ 1412)

All XL super low noise version are supplied, as standard, with the latest 'Floating Frame' technology that completely isolates the compressors from the main casing, thereby eliminating vibration and noise from this source. The 'Floating Frame' is a special vibration and acoustic damping system that consists of a base plate and acoustic enclosure that houses the compressors. The base plate is separated from the supporting frame of the unit by soft steel springs that have a high damping power. Within the enclosure, the compressors are mounted on rubber shock absorbers on the floating base plate. The enclosure is manufactured from galvanized steel sandwich panels that have a micro-perforated inner skin and a core of 50 mm thick, high density (40 kg/m³) mineral wool. The entire arrangement provides a double damping system and acoustic attenuation. The compressor refrigerant pipes are connected to the refrigerant circuit through "anaconda" flexible connections. Flexible connections are also used on the water pipework within the unit. The combination of these systems results in an overall noise reduction in the region of 6-8 dB(A).

3.3 Accessories description

3.3.1 Low noise version (LS)

This version includes the complete acoustic insulation of the unit (compressor + heat exchangers vanes) with compressor jackets and insulating material made with high density media and the interposition of heavy bitumen layer.

3.3.2 Rubber vibration dampers (KAVG)

To be installed beneath the unit base and the ground to avoid the transmission of vibrations (and the noise) to the building.

3.3.3 Spring vibration dumpers (KAVM)

To be installed beneath the unit base and the ground to avoid the transmission of vibrations (and the noise) to the building.

3.3.4 Pressure gauges (MAML)

These enable the standing charge and the operating pressures to be monitored.

3.3.5 Electronic soft starter (DSSE)

It is used to reduce the peak current of the unit; the average reduction is 40% of the nominal peak current.

3.3.6 Remote control panel(PCRL)

It allows the remote control of all parameters of the unit.

3.3.7 RS485 serial interface card MODBUS protocol (INSE)

It is used to connect the unit to BMS systems using MODBUS protocol.

3.3.8 Source water 2 way modulating valve (4-20 mA; 0-10 V) (V2MO)

2-way modulating valve is factory installed in the hydraulic circuit at the source side, to optimize the consumption of well water as a function of the temperature of the available water. The valve is controlled by the microprocessor control unit by modulating signal 0-10V. In the event of lack of power supply, the valve is normally closed.

3.3.9 Electronic expansion valve (VTEE)

The electronic expansion valve enables the maximum possible efficiency to be achieved by maximising the evaporator heat exchange, minimising the reaction time to load variations and optimising the superheat . It is strongly recommended for use in systems that will experience large load variations.

3.4 Technical data

HH/LT		312	412	612	712	912	1212	1412	1804	2304	2604
Heating capacity (EN14511) ⁽¹⁾	kW	38,8	46,0	58,4	70,3	88,4	109,9	136,5	176,9	219,5	273,2
Input power (EN14511) ⁽¹⁾	kW	8,2	9,4	11,8	14,8	18,8	23,1	27,9	37,2	45,7	55,3
COP (EN14511) ⁽¹⁾	W/W	4,73	4,85	4,93	4,76	4,70	4,75	4,88	4,75	4,80	4,94
Energy Class in low temperature ⁽²⁾		A+++	A+++	A+++	A+++	A+++	A+++	A+++	A+++	A+++	A+++
SCOP low temperature ⁽²⁾	kWh/kWh	4,85	5,00	5,16	5,00	5,08	5,17	5,36	5,29	5,38	5,56
$\eta_{s,h}$ low temperature ⁽²⁾	%	185,9	192,1	198,2	191,8	195,3	198,9	206,3	203,4	207,0	214,4
Energy Class in medium temperature ⁽²⁾		A++	A++	A++	A++	A++	A++	A++	A++	A++	A++
SCOP medium temperature ⁽²⁾	kWh/kWh	4,07	4,19	4,28	4,18	4,16	4,22	4,35	4,27	4,34	4,47
$\eta_{s,h}$ medium temperature ⁽²⁾	%	154,8	159,6	163,0	159,0	158,3	160,9	165,9	162,8	165,6	170,7
Power supply	V/Ph/Hz	400/3/50	400/3/50	400/3/50	400/3/50	400/3/50	400/3/50	400/3/50	400/3/50	400/3/50	400/3/50
Peak current	A	128,7	137,6	168,0	209,0	266,0	324,0	372,5	348,0	428,0	497,5
Maximum input current	A	35,4	39,2	56,0	70,0	82,0	104,0	125,0	164,0	208,0	250,0
Compressors / Circuits	n°/n°	2/1	2/1	2/1	2/1	2/1	2/1	2/1	4/2	4/2	4/2
Capacity steps	n°	2	2	2	2	2	2	2	4	4	4
Refrigerant		R134a	R134a	R134a	R134a	R134a	R134a	R134a	R134a	R134a	R134a
Global warming potential (GWP)		1430	1430	1430	1430	1430	1430	1430	1430	1430	1430
Refrigerant charge	kg	2,0	2,0	3,0	3,0	4,0	5,0	6,0	8,5	10,5	13,0
Equivalent CO ₂ charge	t	2,9	2,9	4,3	4,3	5,7	7,2	8,6	12,2	15,0	18,6
Sound power LS version ⁽³⁾	dB(A)	--	--	--	--	--	--	--	88	89	91
Sound pressure LS version ⁽⁴⁾	dB(A)	--	--	--	--	--	--	--	72	73	75
Sound power XL version ⁽³⁾	dB(A)	65	65	70	73	74	76	78	--	--	--
Sound pressure XL version ⁽⁴⁾	dB(A)	49	49	54	57	58	60	62	--	--	--

HH/HT		161	211	312	412	612	712	912	1212	1412	1804	2304	2604
Heating capacity (EN14511) ⁽¹⁾	kW	18,5	21,8	37,6	43,6	64,1	75,1	97,8	121,7	150,5	195,6	243,9	301,2
Input power (EN14511) ⁽¹⁾	kW	3,4	3,7	6,7	7,5	11,1	13,7	17,6	21,7	26,2	35,0	43,1	52,2
COP (EN14511) ⁽¹⁾	W/W	5,64	5,89	5,65	5,83	5,79	5,48	5,56	5,62	5,74	5,59	5,65	5,77
Energy Class in low temperature ⁽²⁾		A+++	A+++	A+++	A+++	A+++	A+++	A+++	A+++	A+++	A+++	A+++	A+++
SCOP low temperature ⁽²⁾	kWh/kWh	5,79	5,9	5,71	5,83	5,91	5,81	5,85	5,94	6,09	5,95	6,01	6,20
$\eta_{s,h}$ low temperature ⁽²⁾	%	223,7	229,2	220,2	225,3	228,2	224,5	226,0	229,4	235,6	230,0	232,4	239,9
Energy Class in medium temperature ⁽²⁾		A+++	A+++	A++	A++	A++	A++	A++	A++	A++	A++	A++	A++
SCOP medium temperature ⁽²⁾	kWh/kWh	4,4	4,53	4,62	4,73	4,78	4,76	4,67	4,74	4,85	4,73	4,79	4,91
$\eta_{s,h}$ medium temperature ⁽²⁾	%	168,1	173,5	176,9	182,1	183,2	182,2	178,7	181,5	186,1	181,0	183,6	188,3
Power supply	V/Ph/Hz	400/3/50	400/3/50	400/3/50	400/3/50	400/3/50	400/3/50	400/3/50	400/3/50	400/3/50	400/3/50	400/3/50	400/3/50
Peak current	A	95	111	111,4	128,7	167,1	208,3	267,9	324,8	372,9	353,7	430,4	498,7
Maximum input current	A	16,4	17,7	32,8	35,4	54,2	68,6	85,8	105,6	125,8	171,6	211,2	251,6
Compressors / Circuits	n°/n°	1/1	1/1	2/1	2/1	2/1	2/1	2/1	2/1	2/1	4/2	4/2	4/2
Capacity steps	n°	1	1	2	2	2	2	2	2	2	4	4	4
Refrigerant		R134a	R134a	R134a	R134a	R134a	R134a	R134a	R134a	R134a	R134a	R134a	R134a
Global warming potential (GWP)		1430	1430	1430	1430	1430	1430	1430	1430	1430	1430	1430	1430
Refrigerant charge	kg	3	3	4,0	4,0	5,0	6,0	8,0	10,0	10,0	21,0	26,0	33,0
Equivalent CO ₂ charge	t	4,3	4,3	5,7	5,7	7,2	8,6	11,4	14,3	14,3	30,0	37,2	47,2
Sound power LS version ⁽³⁾	dB(A)	--	--	--	--	--	--	--	--	--	88	89	91
Sound pressure LS version ⁽⁴⁾	dB(A)	--	--	--	--	--	--	--	--	--	72	73	75
Sound power XL version ⁽³⁾	dB(A)	62	62	65	65	70	73	74	76	78	--	--	--
Sound pressure XL version ⁽⁴⁾	dB(A)	46	46	49	49	54	57	58	60	62	--	--	--

Performances are referred to the following conditions:

(1) Heating: user water temperature 30/35°C, source water temperature 10/7°C.

(2) Average conditions, variable - Reg EU 811/2013

(3) Sound power level in accordance with ISO 3744.

(4) Sound pressure level at 1 mt from the unit in free field conditions direction factor Q=2, calculated in accordance with ISO 3744.

3.5 Operation limits

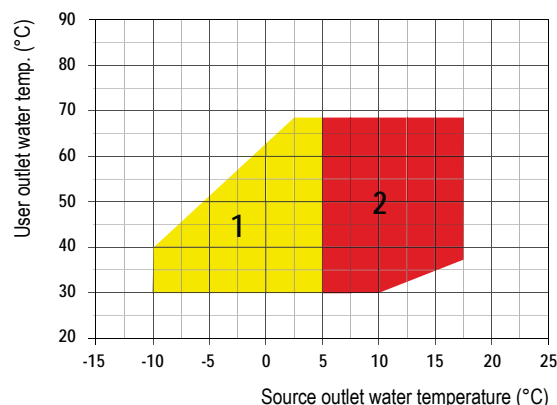
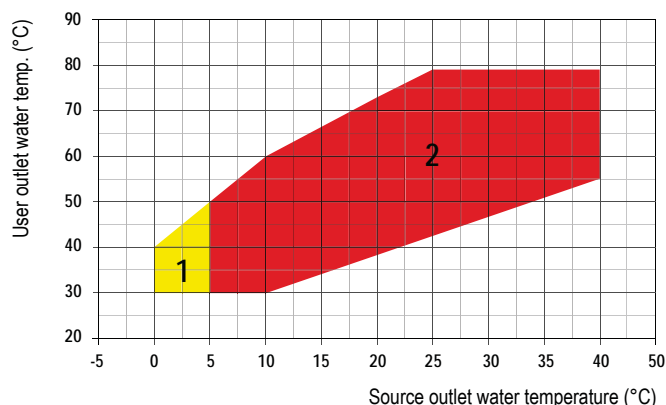

1 Standard version with glycol (LT)

2 Standard version

3.5.1 User heat exchanger water flow rate

The nominal water flow rate given is referred to a Dt of 5 °C. Maximum flow rate allowed is the one that presents a Dt of 3 °C: higher values may cause too high pressure drop. The minimum water flow rate allowed is the one presenting a Dt of 8 °C. Insufficient values cause too low evaporating temperatures with the action of safety devices which would stop the unit.

3.5.2 User hot water temperature

Once the system is on temperature, the minimum user water temperature should not be less than 30 °C: Lower values could cause incorrect working operation of the compressor and compressor failure may occur. The maximum user outlet water temperature cannot exceed 70°C (LT) 78°C (HT); higher values may call the action of safety devices which would stop the unit.

3.5.4 Source water temperature

The minimum source water outlet temperature is, in heating mode, 5°C. To operates below this limit a glycol mixture must be used. In case of use with this glycol mixture the minimum source water outlet temperature is -10°C (LT) 0°C(HT). The maximum source water outlet temperature is 18°C (LT) 40°C (HT).



Units are designed and manufactured to European safety and technical standards. The units have been designed exclusively for heating, cooling and domestic hot water production (D.H.W.). The units must be used for this specific purpose only. The Company will not be liable for claims for damage caused to persons, animals or material goods or property caused by improper installation, adjustment and maintenance or improper use. Any use not specified in this manual is prohibited.



In case of operations outside of these values, please contact the company.

3.6 Compressor capacity steps

Model	NUMBER of COMPRESSORS			
	1	2	3	4
161	100%	--	--	--
211	100%	--	--	--
312	50%	50%	--	--
412	50%	50%	--	--
612	50%	50%	--	--
712	50%	50%	--	--
912	50%	50%	--	--
1212	50%	50%	--	--
1412	50%	50%	--	--
1804	25%	25%	25%	25%
2304	25%	25%	25%	25%
2604	25%	25%	25%	25%

3.7 Correction tables

3.7.1 Operation with glycol

Glycol percentage	Freezing point (°C)	CCF	IPCF	WFCF	PDCF
10	-3,2	0,985	1	1,02	1,08
20	-7,8	0,98	0,99	1,05	1,12
30	-14,1	0,97	0,98	1,09	1,22
40	-22,3	0,965	0,97	1,14	1,25
50	-33,8	0,955	0,965	1,2	1,33

CCF: Capacity correction factor

IPCF: Input power correction factor

WFCF: Water flow correction factor

PDCF: Pressure drops correction factor

The water flow rate and pressure drop correction factors are to be applied directly to the values given for operation without glycol. The water flow rate correction factor is calculated in order to maintain the same temperature difference as that which would be obtained without glycol. The pressure drop correction factor takes into account the different flow rate obtained from the application of the flow rate correction factor.

3.7.2 Correction tables different Δt

Water temperature diff.(°C)	3	5	8
CCCP	0,99	1	1,02
IPCF	0,99	1	1,01

CCCP = Cooling capacity correction factor

IPCF = Input power correction factor

3.7.3 Correction tables different Fouling factors

Fouling factor	0,00005	0,0001	0,0002
CCCP	1	0,98	0,94
IPCF	1	0,98	0,95

CCCP = Cooling capacity correction factor

IPCF = Input power correction factor

3.8 Sound data

LS											
Mod.	Octave bands (Hz)								Lw		Lp
	63 dB	125 dB	250 dB	500 dB	1K dB	2K dB	4K dB	8K dB	dB	dB(A)	dB(A)
161	--	--	--	--	--	--	--	--	--	--	--
211	--	--	--	--	--	--	--	--	--	--	--
312	--	--	--	--	--	--	--	--	--	--	--
412	--	--	--	--	--	--	--	--	--	--	--
612	--	--	--	--	--	--	--	--	--	--	--
712	--	--	--	--	--	--	--	--	--	--	--
912	--	--	--	--	--	--	--	--	--	--	--
1212	--	--	--	--	--	--	--	--	--	--	--
1412	--	--	--	--	--	--	--	--	--	--	--
1804	101	92	86	85	84	78	75	66	102	88	72
2304	102	93	87	86	85	79	76	67	103	89	73
2604	104	95	89	88	87	81	78	69	105	91	75

XL											
Mod.	Octave bands (Hz)								Lw		Lp
	63 dB	125 dB	250 dB	500 dB	1K dB	2K dB	4K dB	8K dB	dB	dB(A)	dB(A)
161	75	66	60	59	58	52	49	40	76	62	46
211	75	66	60	59	58	52	49	40	76	62	46
312	78	69	63	62	61	55	52	43	79	65	49
412	78	69	63	62	61	55	52	43	79	65	49
612	83	74	68	67	66	60	57	48	84	70	54
712	86	77	71	70	69	63	60	51	87	73	57
912	87	78	72	71	70	64	61	52	88	74	58
1212	89	80	74	73	72	66	63	54	90	76	60
1412	91	82	76	75	74	68	65	56	92	78	62
1804	--	--	--	--	--	--	--	--	--	--	--
2304	--	--	--	--	--	--	--	--	--	--	--
2604	--	--	--	--	--	--	--	--	--	--	--

Lw: Sound power level according to ISO 3744.

Lp: Sound pressure level measured at 1 mt from the unit in free field conditions direction factor Q=2 according to ISO 3744.

4. INSTALLATION

4.1 General safety guidelines and use of symbols



Before undertaking any task the operator must be fully trained in the operation of the machines to be used and their controls. They must also have read and be fully conversant with all operating instructions.



All maintenance must be performed by TRAINED personnel and be in accordance with all national and local regulations.



The installation and maintenance of the unit must comply with the local regulations in force at the time of the installation.



Avoid contact and do not insert any objects into moving parts.

4.2 Health and safety Considerations



The workplace must be kept clean, tidy and free from objects that may prevent free movement. Appropriate lighting of the work place shall be provided to allow the operator to perform the required operations safely. Poor or too strong lighting can cause risks.



Ensure that work places are always adequately ventilated and that respirators are working, in good condition and comply fully with the requirements of the current regulations.

4.3 Personal protective equipment



When operating and maintaining the unit, use the following personal protective equipment listed below, required by law.



Protective footwear.



Eye protection.



Protective gloves.



Respiratory protection.



Hearing protection.

4.4 Inspection

When installing or servicing the unit, it is necessary to strictly follow the rules reported on this manual, to conform to all the specifications of the labels on the unit, and to take any possible precautions of the case. Not observing the rules reported on this manual can create dangerous situations. After receiving the unit, immediately check its integrity. The unit left the factory in perfect conditions; any eventual damage must be questioned to the carrier and recorded on the Delivery Note before it is signed. The company must be informed, within 8 days, of the extent of the damage. The Customer should prepare a written statement of any severe damage.

Before accepting the unit check:

- The unit did not suffer any damage during transport;
- The delivered goods are conforming to what shown in the delivery note.

In Case of Damage

- List the damage on the delivery note
- Inform the Company of the extent of the damage within 8 days of receipt of the goods. After this time any claim will not be considered.
- A full written report is required for cases of severe damage.

4.5 Storage

Units should be stored under cover and ideally, should remain in their packaging. The tools that are supplied for opening the electric box should be formally transferred to the person responsible for the plant.

4.5.1 Shipment

The shipment must be carried out by authorised carriers and the characteristics of the vehicle used must be such as to avoid damaging the machinery transported/to be transported, neither during loading and unloading nor during transport. If the roads to be driven are irregular, the vehicle must be fitted with special suspensions or internal walls in order not to damage the unit during the shipment.



The maximum ambient temperature for storage/shipment is +45°C and the minimum is -20°C,

4.6 Unpacking



Packaging could be dangerous for the operators.

It is advisable to leave packaged units during handling and remove it before the installation. The packaging must be removed carefully to prevent any possible damage to the machine. The materials constituting the packaging may be different in nature (wood, cardboard, nylon, etc.).



The packaging materials should be separated and sent for disposal or possible recycling to specialist waste companies.

Prior to unpacking and installing the unit, it is prudent to read this manual, note the information provided on the labels on the unit and to take all precautions required for safe working and to avoid damage. Non compliance with the warnings can create dangerous situations.

4.7 Lifting and handling

When unloading the unit, it is highly recommended to avoid any sudden move in order to protect refrigerant circuit, copper tubes or any other unit component. Units can be lifted by using a forklift or, in alternative, using belts, being sure that the method of lifting does not damage the lateral panels and the cover. It is important to keep the unit horizontal at all time to avoid damages to the internal components.

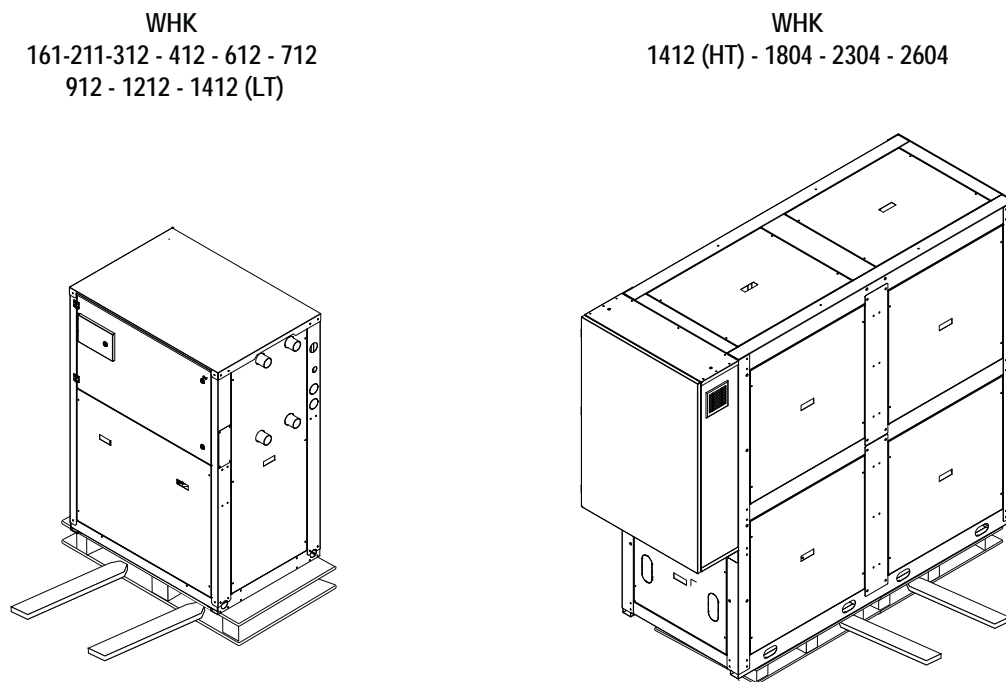

4.8 Location and minimum technical clearances



The unit has to be installed such that maintenance and repair is possible. The warranty does not cover costs for the provision of lifting apparatus, platforms or other lifting systems required to perform repairs during warranty period.



The installation site should be chosen in accordance with EN 378-1 and 378-3 standards. When choosing the installation site, all risks caused by accidental refrigerant leakage should be taken into consideration.

All models are designed and built for indoor installations, it is a good idea to create a base of support to those of the appropriate size, the units transmit to a low level of ground vibration: it is advisable to interpose between the frame base and the ground plane of vibration absorbers (spring or rubber), In this regard it is necessary to guarantee the minimum service below.

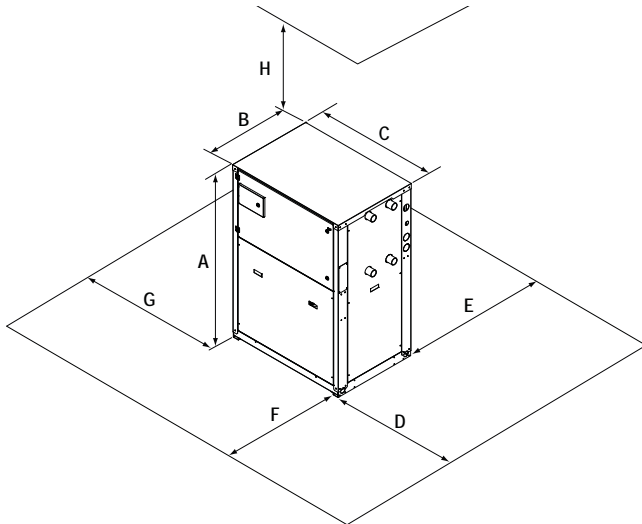

Mod.	A	B	C	D	E	F	G	H
161	1631	790	1145	1000	500	1000	500	500
211	1631	790	1145	1000	500	1000	500	500
312	1631	790	1145	1000	500	1000	500	500
412	1656	790	1145	1000	500	1000	500	500
612	1656	790	1145	1000	500	1000	500	500
712	1656	790	1145	1000	500	1000	500	500
912	1656	790	1145	1000	500	1000	500	500
1212	1656	790	1145	1000	500	1000	500	500
1412 (LT)	1656	790	1145	1000	500	1000	500	500

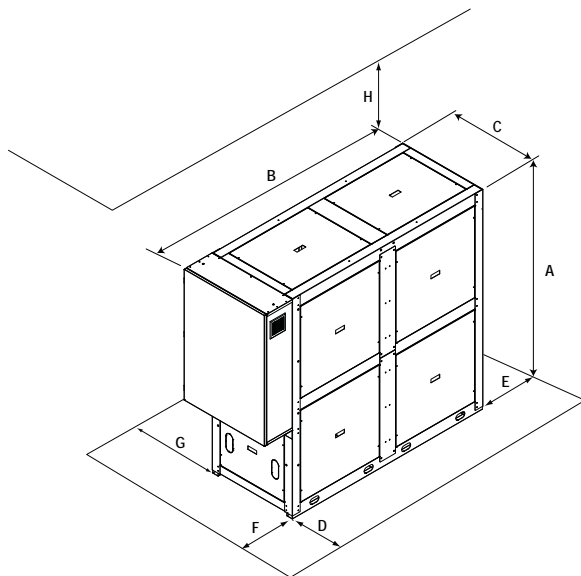

Mod.	A	B	C	D	E	F	G	H
1412 (HT)	1900	2177	794	1000	500	800	1000	500
1804	1900	3127	794	1000	500	800	1000	500
2304	1900	3127	794	1000	500	800	1000	500
2604	1900	3127	794	1000	500	800	1000	500

4.9 Installation of rubber vibration dampers (KAVG)

All units should be installed on vibration dampers in order to prevent the transmission of vibration to the supporting surface and reduce the noise level. Rubber vibration dampers are available as an option in the catalogue. The vibration dampers (optional) are supplied by the factory in separate packaging.

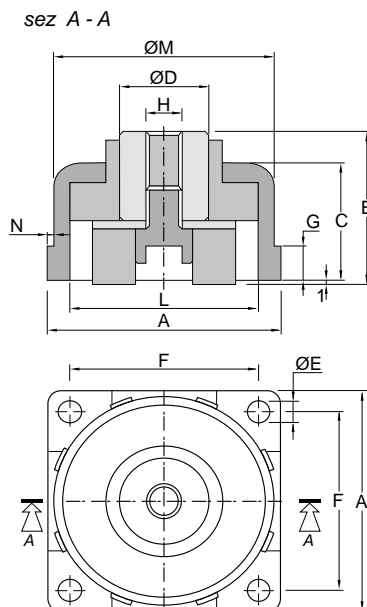

Mod.	A	B	C	D	E	F	G	H	L	M	N
161÷612	88 mm	52 mm	41 mm	25 mm	11 mm	67 mm	10 mm	M12	65 mm	74,5 mm	5,5 mm
712÷1412	88 mm	52 mm	41 mm	25 mm	11 mm	67 mm	10 mm	M12	65 mm	74,5 mm	5,5 mm
1804÷2604	88 mm	52 mm	41 mm	25 mm	11 mm	67 mm	10 mm	M12	65 mm	74,5 mm	5,5 mm

4.10 Serial interface card RS485 (INSE)

Supervision system interface serial board (MODBUS RS485 available only)

The installation of the card will allow the unit to be plugged in and connected to a system with MODBUS protocol. This system allows you to remotely monitor all parameters of the unit and change their values.

The serial interface board is normally fitted at the factory, where it is provided separately is necessary to respect the polarity of the wiring as shown in the diagram. Any reversal of polarity will result in the non-functioning unit. The supervision connectivity cable must be telephone one type 2x0,25 mm².

The unit is configured at the factory with serial address 1. In case of using the MODBUS system, you can request the list of variables by contacting the assistance.

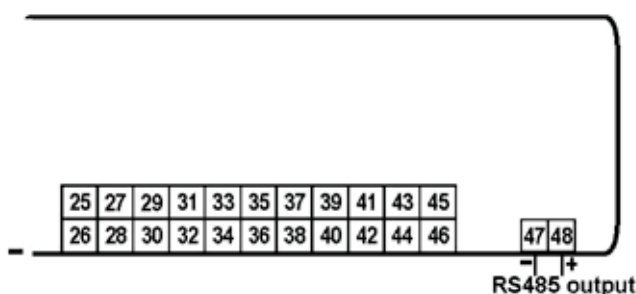

4.11 Source water pump installation

Recently there has been a continuous increase in installations where the variable speed source water pump (inverter type) is used. The company states that it is of fundamental importance the correct flow rate of water source in order to avoid problems of freezing of the source heat exchanger. In this regard it is noted that the source water pump should be exclusively dedicated to the heat pump and, preferably, the ON / OFF type.



In the case of using the source water pump for other purposes (irrigation, etc..) and you need a variable speed pump (inverter type) , undertakes the installation of the modulating valve. In these cases, the pump must ensure a constant pressure at the inlet of the source circuit of the heat pump of at least 3 bars, regardless of the type and number of active users.



In case of variation of the water flow to the source circuit there is a risk of freezing of the source heat exchanger. In this case the warranty expires immediately.



The activation of the modulating valve shows a selector used to vary the type of signal and the sense of rotation of the valve itself. Tampering can undermine the correct operation of the valve precluding security.

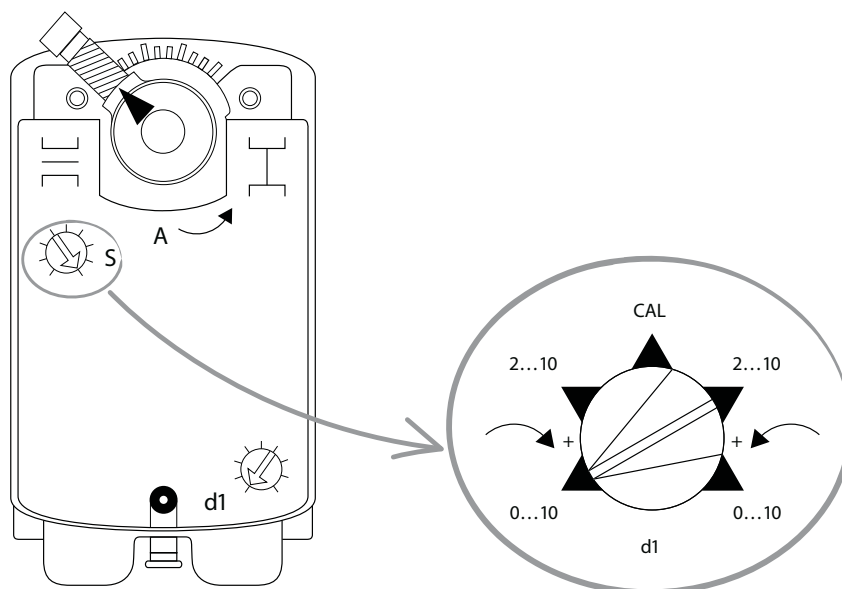

4.12 Hydraulic connections

The water pipe-work must be installed in accordance with national and local regulation and can be made from copper, steel, galvanized steel or PVC. The Pipework must be designed to cater for the nominal water flow and the hydraulic pressure drops of the system, a maximum pressure drop of 300 Pa/m run being typical. All pipes must be insulated with closed-cell material of adequate thickness. The hydraulic piping should include:

- Pockets for temperature sensor to measure the temperature in the system.
- Flexible joints, to isolate the unit from the rest of the system
- Temperature and pressure gauges for maintenance and servicing operations.
- Shut-off manual valves to isolate the unit from the hydraulic circuit.
- Metallic filters to be mounted on the inlet pipe with a mesh not larger than 1 mm.
- Vent valves, expansion tank with water filling, discharge valve.



System return water must be fitted to the connection labelled: "USER WATER IN" as incorrect connection can damage the heat exchanger by freezing.



The flow switch **MUST BE FITTED** in the pipework connection labelled "USER WATER OUT."



It is compulsory to install on the USER WATER IN connection, a water strainer with a mesh not larger than 1 mm. Fitting this filter is **COMPULSORY** and the warranty will be invalidated if it is removed. The filter must be kept clean and checked periodically.



The water flow through the heat exchangers of the unit should not be fall below Δt 8°C measured at the following conditions:

Heating mode: 10/7°C Dry bulb ambient temperature 35°C water outlet temperature

4.13 Chemical characteristics of the water

The system is to be filled with clean water and vented after a full flushing operation has been performed; the water should have the following characteristics :

PH	6-8	Total Hardness	Lower Than 50 ppm
Electric conductivity	Lower Than 200 mV/ cm (25°C)	Sulphur ion	None
Chlorine ions	Lower Than 50 ppm	Ammonia ion	None
Sulphuric acid ions	Lower Than 50 ppm	Silicon ion	Lower Than 30 ppm
Total Iron	Lower Than 0,3 ppm		

4.14 User circuit minimum water content



Like any refrigerant unit also the heat pumps need a minimum water content in the user hydraulic circuit to guarantee a correct operation of the units, avoiding a high numbers of start and stop of the compressors that can reduce the working life of the unit.

Model	161	211	312	412	612	712	912	1212	1412	1804	2304	2604
Minimum water content (l)	500	600	500	600	750	850	1200	1500	1700	1200	1500	1700
Safety valve (bar)	6	6	6	6	6	6	6	6	6	6	6	6

4.15 Installation with source open circuit (water to water heat pump)

The source water circuit of a water to water heat pump is generally an open circuit, with sampling from a well or a water reservoir. The hydraulic source MUST include appropriate safety devices to protect the 3 major problems encountered:

- Corrosion: generated by the chemical composition of water;
- Clogging: caused by mud and / or suspended organic and inorganic compounds in water;
- Freezing: caused by too low temperature of the fluid source.

4.16 Chemical characteristics of source water circuit

Carbonic acid dissolved	(CO ₂)	< 5 mg/kg	Gas chloride free	(Cl ₂)	< 1 mg/kg
Hydrogen peroxide sulfur	(H ₂ S)	< 0,05 mg/kg	Manganese	(Mn)	< 0,1 mg/kg*
Ammonia	(NH ₃)	< 2 mg/kg	Nitrate	(NO ₃)	< 100 mg/kg
Chloride	(Cl)	< 100 mg/kg	Oxygen	(O ₂)	< 2 mg/kg*
Chloride free	(Cl)	< 0,5 mg/kg	Sulphate	(SO ₄ ²⁻)	< 50 mg/kg
Electrical conductivity		>50µS/cm e <600µS/cm	Sulfites	(SO ₃)	< 1 mg/kg
Iron	(Fe)	< 0,2 mg/kg*	pH Value		6,5 – 9,0

*An excess of these limits due to a blockage of mud in the source heat exchanger and piping.



Warranty does not cover any damage caused by corrosion, clogging and freezing if attributable to lack and / or incorrect installation of described safety devices



The use of source water generally requires approval by the municipality and / or the province. Check with local authorities.



The limit values in the table may cause clogging by mud in the pipes and the heat exchanger.



The maintenance of the quality of source water is borne by the user and / or maintenance company.



The temperature of source water at the inlet of the source heat exchanger in heating mode, must not fall below 7-8°C to avoid freezing problems in the source circuit. The fact is average water cooling of about 3-5°C, resulting in temperature of the fluid outlet from the heat pump, in this case an inlet water temperature less than 7°C is dangerously close to the temperature of formation of ice.



The temperature of the source water at the inlet of source heat exchanger in heating mode, should never exceed 25°C as this may activate the control devices and safety unit. For applications with temperatures above 25°C water temperature, please contact the company.



In case of installation in sites with source water temperatures close to the above it is recommended to test for water consumption for a minimum period of 36 consecutive hours (to be made, possibly, towards the end of winter season).

4.17 Hydraulic components

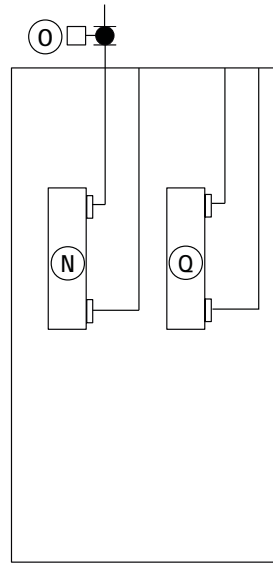

L	Water Pump	O	Flow Switch
N	User heat exchanger	Q	Source heat exchanger



If the unit is supplied without a pump, the pump must be installed with the supply side toward the water inlet connection of the unit.

4.17.1 Solution 1

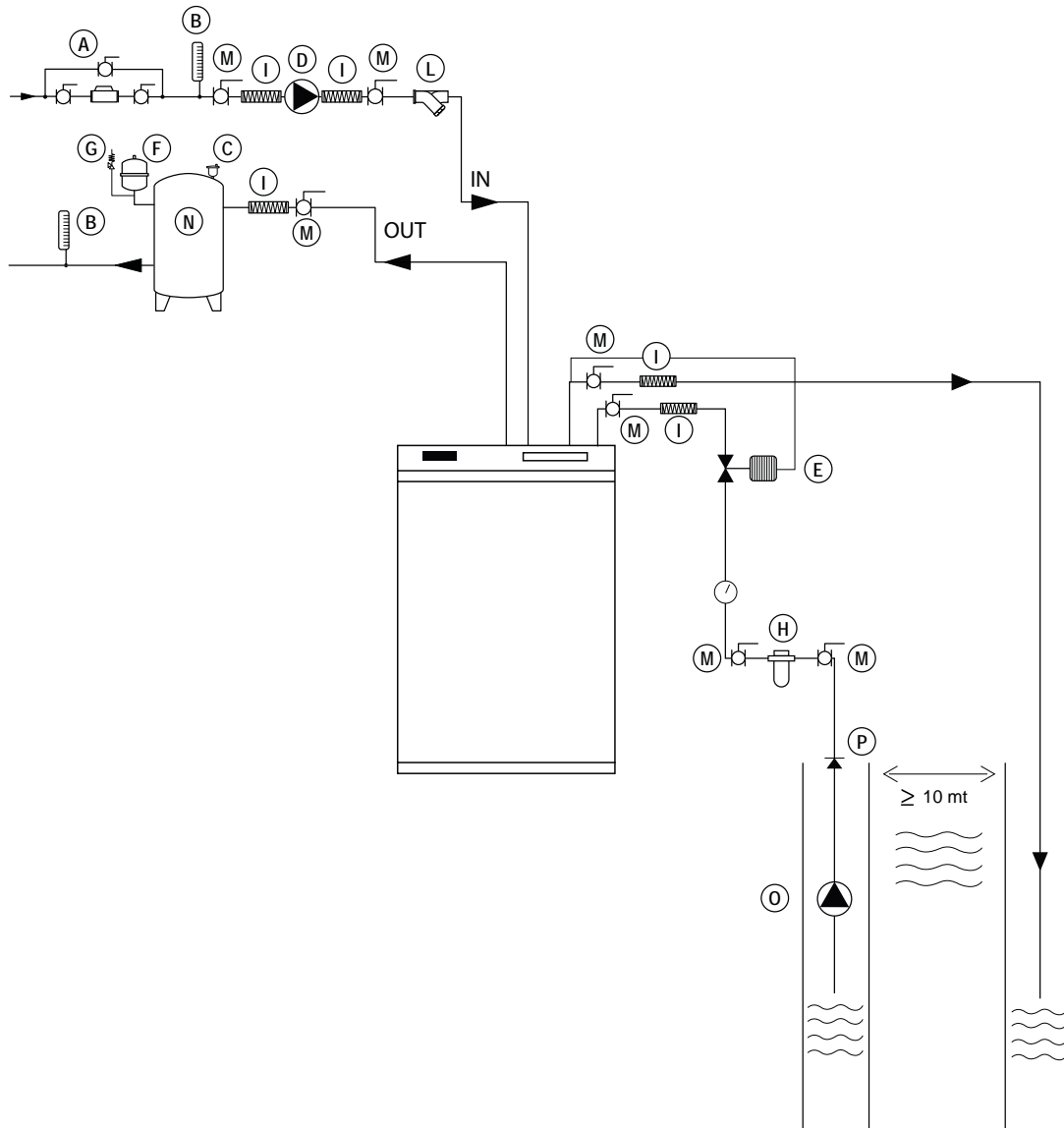

The above system is the most economical and efficient, but it can be used ONLY in cases where a water quality parameters are within the limits shown in the table. It is ALWAYS recommended to perform an accurate chemical analysis of water by a qualified technician. In the case where it is not possible to maintain control the water quality parameters listed above there has to opt for a source hydraulic circuit type 2.

A	System Filling Group	H	Source water Filter
B	Thermometer	I	Flexible Connection
C	Vent Valve	L	User water Filter
D	Circulating pump	M	Manual valve
E	Source modulating valve	N	Water tank
F	Expansion Vessel	O	Well pump
G	Safety Valve	P	Check valve



The pump (O) must be installed with the water supply side facing the unit water inlet connection.

4.17.2 Solution 2

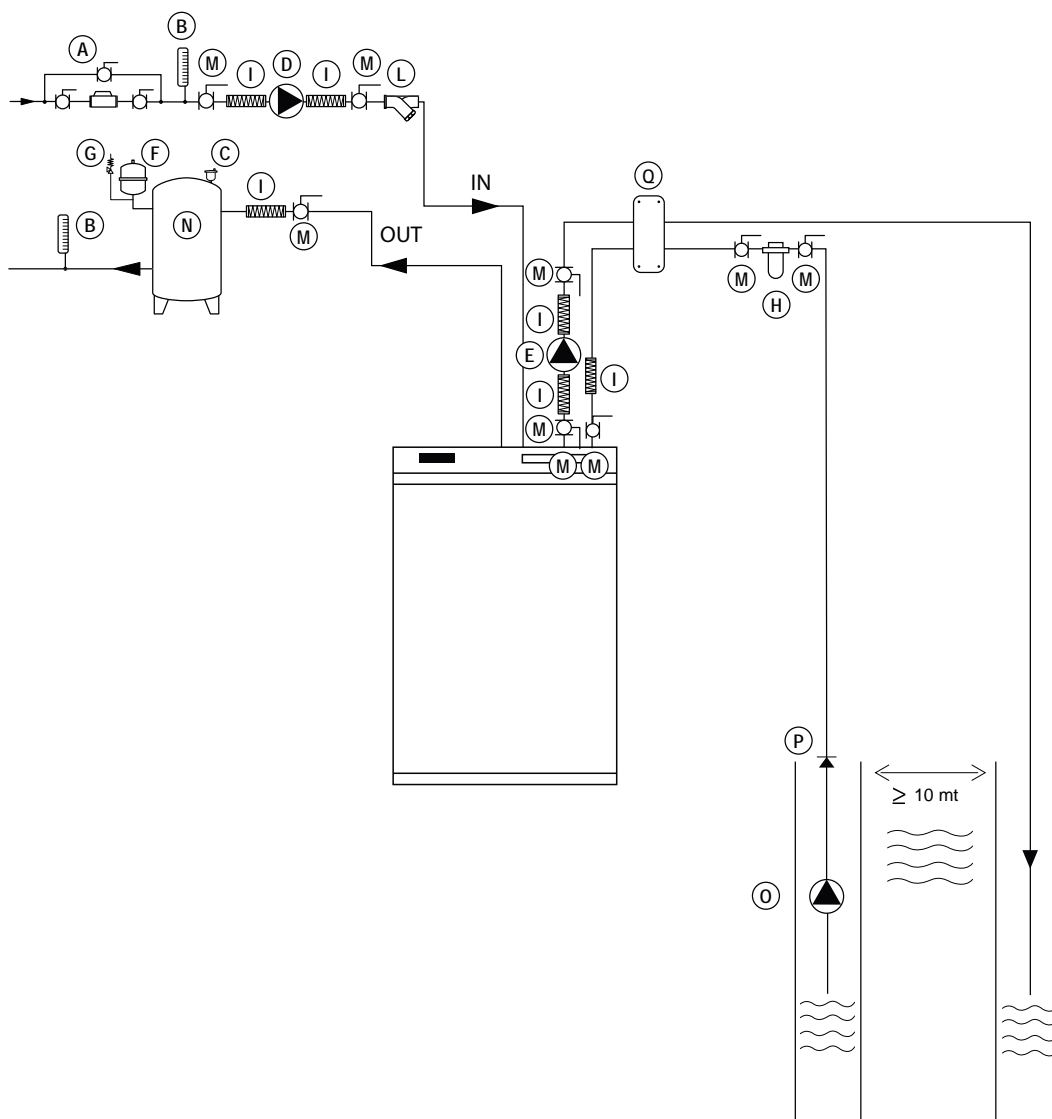

The system above is the most secure and reliable, involves the installation of an intermediate water –water plate heat exchanger which protects the source of the heat pump from clogging, corrosion and freezing. This hydraulic circuit is strongly recommended in those installations where it is not possible to maintain control the water quality parameters listed above. The installation of the intermediate heat exchanger lead to lower performance of the unit and requires an auxiliary pump. Please contact the Company in case of need for sizing of the intermediate heat exchanger.

A	System Filling Group	I	Flexible Connection
B	Thermometer	L	User water Filter
C	Vent Valve	M	Manual valve
D	Circulating pump	N	Water tank
E	Source pump	O	Well pump
F	Expansion Vessel	P	Check valve
G	Safety Valve	Q	Medium heat exchanger
H	Source water Filter		



The pump must be installed with the water supply side facing the unit water inlet connection.

4.17.3 Solution 3

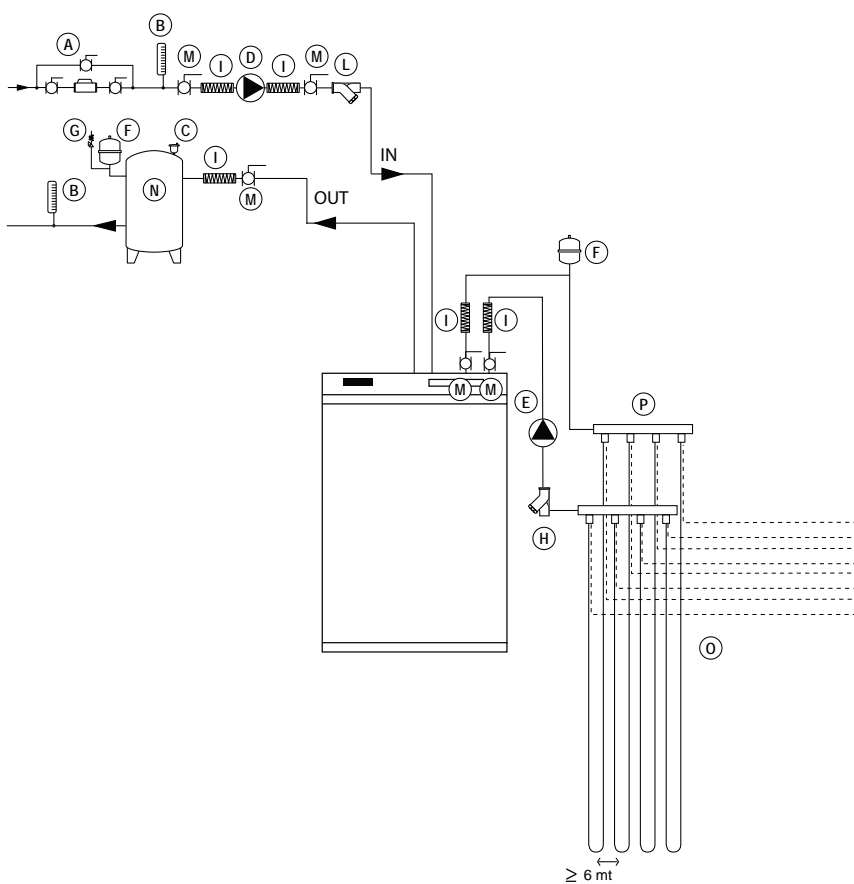

The above system refers to an application with geothermal probes vertical or horizontal. In the majority of vertical applications using PE pipes connected in parallel, placed at a distance of at least 6 meters. Normally the vertical perforations must be approved by local authorities. In case of horizontal applications will typically use PE pipes buried about 1.5 to 2 meters deep.

A	System Filling Group	H	Source water Filter
B	Thermometer	I	Flexible Connection
C	Vent Valve	L	User water Filter
D	Circulating pump	M	Manual valve
E	Source modulating valve	N	Water tank
F	Expansion Vessel	O	Geothermal probes
G	Safety Valve	P	Collector probes



The geothermal probes must be correctly sized with glycol as a function of their operating temperature. It is recommended to contact the manufacturer of the individual probes for more details.



The pump must be installed with the water supply side facing the unit water inlet connection.

This heat pump is typically not used in combination with a well / geothermal system. It's typically used with sources like process heat or pre-heated low temperature water from an air- source heat pump or water/water heat pump in an Aquifer Thermal Energy Storage (ATES) system.

4.18 Domestic hot water (DHW) hydraulic circuit



The domestic hot water (DHW) circuit also requires a minimum water content to guarantee correct operation and to avoid excessive cycling of the compressors that can reduce the working life of the unit.

The minimum domestic hot water circuit content required is:

Model	161	211	312	412	612	712	912	1212	1412	1804	2304	2604
Minimum water content (l)	500	600	500	600	750	850	1200	1500	1700	1200	1500	1700
Safety valve (bar)	6	6	6	6	6	6	6	6	6	6	6	6



The minimum domestic hot water circuit content shown in the above table shows the minimum water content required by the system to guarantee the correct operation of the unit in terms of the acceptable number of starts of the compressors and the minimum allowed working time per cycle. **The above values do not guarantee the availability and temperature of domestic hot water;** the correct volume **MUST** be calculated based upon the domestic hot water system type and on the user requirements. Please contact technical support team for information regarding this.

4.19 Filling the hydraulic circuit

- Before filling, check that the system drain valve is closed.
- Open all pipework, heat pump and terminal unit air vents.
- Open the shut off valves.
- Begin filling, slowly opening the water valve in the filling group outside the unit.
- When water begins to leak out of the terminal unit air vents, close them and continue filling until the pressure gauge indicates a pressure of 1.5 bar.

The installation should be filled to a pressure of between 1 and 2 bars. It is recommended that this operation be repeated after the unit has been operating for a number of hours (due to the presence of air bubbles in the system). The pressure of the installation should be checked regularly and if it drops below 1 bar, the water content should be topped-up. If frequent top-ups are required, check all connections for leaks.

4.20 Emptying the installation

- Before emptying, place the mains switch in the "Off" position.
- Make sure the filling group valve is closed.
- Open the drainage valve outside the unit and all the installation and terminal air vent valves.



If the fluid in the circuit contains anti-freeze, it **MUST** not be allowed to run away to drain. It must be collected for possible re-cycling or for correct disposal.

4.22 Electric connections: preliminary safety information

The electric panel is located inside the unit at the top of the technical compartment where the various components of the refrigerant circuit are also to be found. To access the electrical board, remove the front panel of the unit:



Power connections must be made in accordance to the wiring diagram enclosed with the unit and in accordance to the norms in force.



Make sure the power supply upstream of the unit is (blocked with a switch). Check that the main switch handle is padlocked and it is applied on the handle a visible sign of warning not to operate.



It must be verified that electric supply is corresponding to the unit electric nominal data (tension, phases, frequency) reported on the label in the front panel of the unit.



Power cable and line protection must be sized according to the specification reported on the form of the wiring diagram enclosed with the unit.



The cable section must be commensurate with the calibration of the system-side protection and must take into account all the factors that may influence (temperature, type of insulation, length, etc.).



Power supply must respect the reported tolerances and limits: If those tolerances should not be respected, the warranty will be invalidated.



Flow switches must be connected following the indication reported in the wiring diagram. Never bridge flow switches connections in the terminal board. Guarantee will be invalidated if connections are altered or not properly made.



Make all connections to ground provided by law and legislation.



Before any service operation on the unit, be sure that the electric supply is disconnected.



FROST PROTECTION

If opened, the main switch cuts the power off to any electric heater and antifreeze device supplied with the unit, including the compressor crankcase heaters. The main switch should only be disconnected for cleaning, maintenance or unit repair.

4.23 Electric data



The electrical data reported below refer to the standard unit without accessories.
In all other cases refer to the data reported in the attached electrical wiring diagrams.



The line voltage fluctuations can not be more than $\pm 10\%$ of the nominal value, while the voltage unbalance between one phase and another can not exceed 1%, according to EN60204. If those tolerances should not be respected, please contact our Company.

Model		161	211	312	412	612	712
Power supply	V/~ /Hz	400/3/50	400/3/50	400/3/50	400/3/50	400/3/50	400/3/50
Control board	V/~ /Hz	24 V	24 V	24 V	24 V	24 V	24 V
Auxiliary circuit	V/~ /Hz	230/1/50	230/1/50	230/1/50	230/1/50	230/1/50	230/1/50
Line section	mm ²	10	10	16	16	35	35
PE section	mm ²	6	6	10	10	25	25

Model		912	1212	1412	1804	2304	2604
Power supply	V/~ /Hz	400/3/50	400/3/50	400/3/50	400/3/50	400/3/50	400/3/50
Control board	V/~ /Hz	24 V	24 V	24 V	24 V	24 V	24 V
Auxiliary circuit	V/~ /Hz	230/1/50	230/1/50	230/1/50	230/1/50	230/1/50	230/1/50
Line section	mm ²	95	95	95	240	240	240
PE section	mm ²	70	70	70	120	120	120



Electric data may change for updating without notice. It is therefore necessary to refer always to the wiring diagram present in the units.

4.24 Electric connections



The numbering of the terminals may change without notice. For their connection is mandatory to refer to the wiring diagram supplied along with the unit.

4.24.1 Remote wiring connections (compulsory)

All terminals referred to in the explanations below are present on the terminal board inside the electrical box, all electric connections mentioned below and have to be made by the installer, on site.

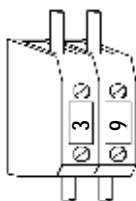

USER CIRCUIT WATER INLET SENSOR (BTI)

It is used to measure the return water temperature from the user circuit. The sensor is always supplied loose in a plastic bag.

As standard working mode, the user pump will be switched off during stand-by periods (Compressors in Off). The sensor must be placed in an appropriate position in order to measure the temperature of the secondary circuit. The incorrect positioning of the user water sensor can have negative influence in the operation of the heat pump. The remote sensor is supplied loose with the unit (it is present inside the electric box) and it is available with 6 mt. cable length. In case the length of the cable is not enough it is recommended to increase the length by only using cable diameter 0,5 mm² to a maximum distance of 50meters.

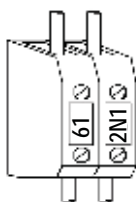

USER CIRCUIT WATER PUMP

If the pump is factory supplied and fitted (A version) it will already be connected otherwise, maximum input current 3A. In standard configuration, the unit microprocessor controller switches off the user water pump when the set point is reached or if the unit is in standby. This strategy is suitable if the unit is heating a buffer store from which a secondary circuit is taken and provides a substantial reduction of energy use.

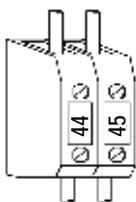

WEATHER COMPENSATED SENSOR (BTE)

This is used to measure the ambient temperature enabling weather compensation modulation of the user set point with respect to the ambient conditions.

4.24.2 Remote wiring connections (optional)

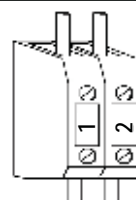

REMOTE ON / OFF

To switch the unit on or off remotely, the cable jumper connected across terminals 1 and 2 must be replaced with a switch.

Contact closed, unit ON,

Contact open, unit OFF.

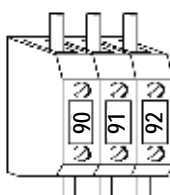

REMOTE GENERAL ALARM

For remote display of a general alarm, connect the visual or audible device between terminals 90-91-92.

Contacts 90/91 NC (Normally closed)

Contacts 91/92 NO (Normally opened)

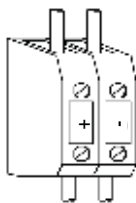

REMOTE CONTROL PANEL

The remote control panel replicates all of the functions on the main controller panel and can be connected up to a maximum distance of 50 meters from the unit. The panel has to be connected to the unit by 2 wires having diameter 0.75 mm². The power supply cables must be separated from the remote control panel wires, in order to avoid interference. The control panel has to be connected to the terminals + and -. The control panel cannot be installed in an area subject to excessive vibration, corrosive gases, is a dirty environment or has a high humidity level. The ventilation openings must not be blocked.

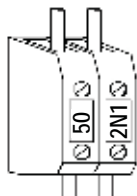

USER CIRCUIT ELECTRIC INTEGRATION HEATERS

If user circuit integration heaters for domestic hot water circuit are required, they must be connected to the specified terminals.

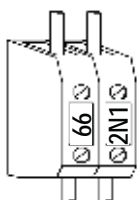

PUMP SOURCE

With maximum current of 3A. In standard configuration, the unit microprocessor control turns off the user water pump when set point is reached. This solution allows a significant reduction in electrical power consumption when the set point is reached or the unit is in standby.

4.24.3 Factory fitted wiring connections

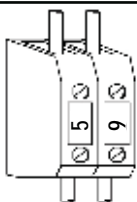

USER CIRCUIT WATER OUTLET SENSOR (BTO)

This is used to measure the outlet user temperature; it is also used as antifreeze protection in cooling mode.

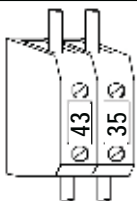

USER CIRCUIT FLOW SWITCH (SFW1)

This is used to protect the unit if there is a low water flow rate in the user circuit. It is factory fitted.

4.25 Refrigerant circuit layout

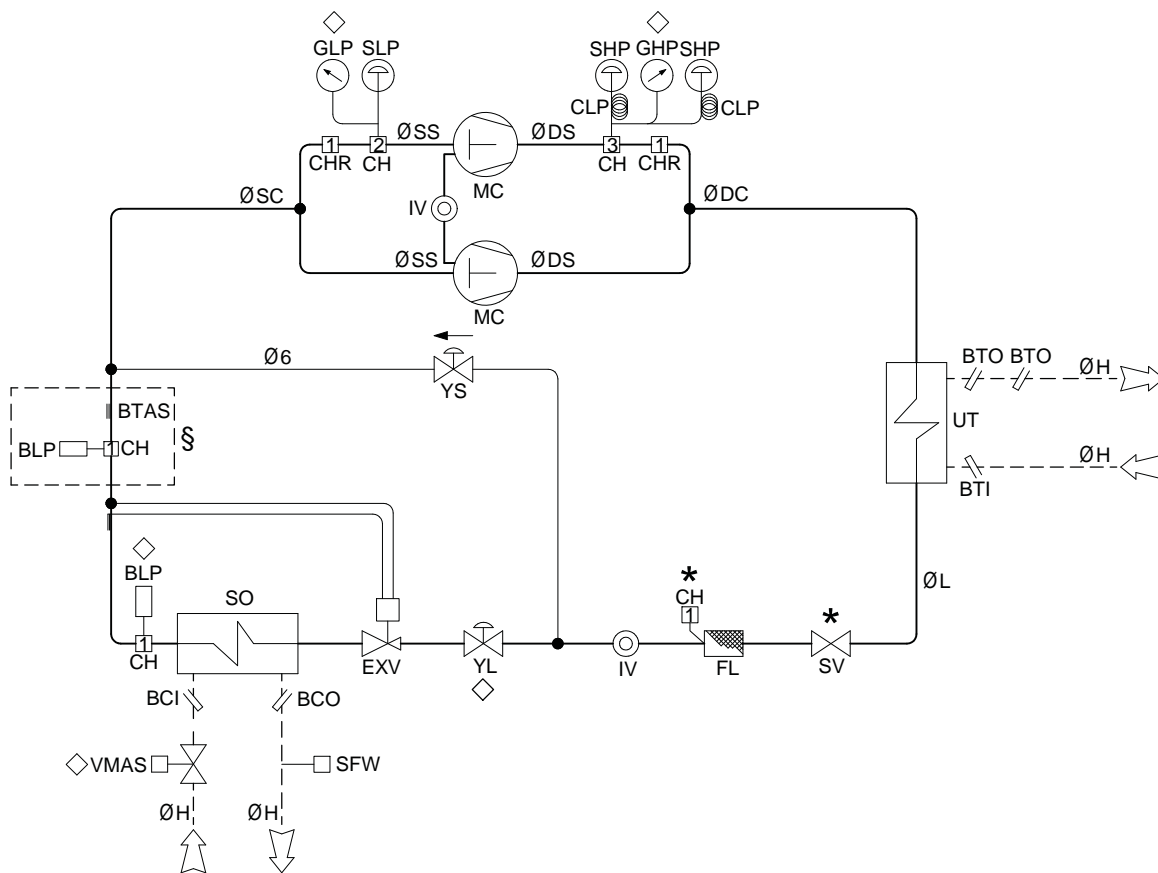

The cooling circuit principle diagram is purely indicative.

BCI	Source water input probe	SHP	High pressure pressostat
BCO	Source water output probe	SLP	Low-high pressure switch
BHP	High pressure transducer	SO	Source side
BLP	Low pressure transducer	SV	Shut off valve
BTFI	Free-cooling probe (inlet water plant)	SW	Sanitary side
BTI	User water input probe	UT	User side
BTO	User water output probe	V3SW5	3-Way water valve sw5
BTS	Sanitary water input probe	V3W	3-Way water valve
BTU	Sanitary water output probe	VMAS	Source water modulating valve
CH	Charging plug 1/4 sae (r407)	VR	Check nvalve
CLP	Expansion capillary tube	VRV	Reverse cycle valve
EXV	Thermostatic valve	YL	Liquid solenoid valve
FL	Liquid line filter	YMC	Chiller solenoid valve
GHP	High pressure gauge	YMS	Sanitary solenoid valve
GLP	Low pressure gauge	YS	Injection solenoid valve
IV	Moisture indicator sight glass	YSO	Source recovery solenoid valve
LR	Liquid receiver	YTSO	Source thermostatic valve solenoid valve
MC	Compressor	YTUT	User thermostatic valve solenoid valve
SFC	Free-cooling side	YUT	User recovery solenoid valve
SFW	Water flow switch	YW	Sanitary recovery solenoid valve

5. UNIT START UP

5.1 Preliminary checks

Before starting the unit the checks detailed in this manual of the electric supply and connections, the hydraulic system and the refrigerant circuit, should be performed.



Start-up operations must be performed in accordance with the instructions detailed in the previous paragraphs.



If it is required to switch the unit on and off, never do this using the main isolator: this should only be used to disconnect the unit from the power supply when the unit is to be permanently off. Isolation will result in no supply for the crankcase heater and on start up the compressor could be seriously damaged.



In the extra low noise versions, be sure to remove the yellow hardware at the base of the compressor before starting.

5.1.1 Before start-up



Damage can occur during shipment or installation. It is recommended that a detailed check is made, before the installation of the unit, for possible refrigerant leakages caused by breakage of capillaries, pressure switch connections, tampering of the refrigerant pipework, vibration during transport or general abuse suffered by the unit.

- Verify that the unit is installed in a workmanlike manner and in accordance with the guidelines in this manual.
- Check that all power cables are properly connected and all terminals are correctly fixed.
- The operating voltage between phases R S T is the one shown on the unit labels.
- Check that the unit is connected to the system earth.
- Check that there is no refrigerant leakage.
- Check for oil stains, sign of a possible leak.
- Check that the refrigerant circuit shows the correct standing pressure on the pressure gauges (if present) otherwise use external ones.
- Check that the Schrader port caps are the correct type and are tightly closed.
- Check that crankcase heaters are powered correctly (if present).
- Check that all water connections are properly installed and all indications on unit labels are observed.
- The system must be flushed, filled and vented in order to eliminate any air.
- Check that the water temperatures are within the operation limits reported in the manual.
- Before start up check that all panels are replaced in the proper position and locked with fastening screws.



Do not modify internal wiring of the unit as this will immediately invalidate the warranty.



Crankcase heaters must be powered at least 12 hours before start up (pre-heating period) To do this, isolate the compressor(s), fans and pump(s) in the electrics box and then switch on the main isolator (heaters are automatically supplied when the main switch is closed). The crankcase heaters are working properly if, after several minutes, the compressor crankcase temperature is about 10÷15°C higher than ambient temperature.



During the 12 hours pre-heating period it is also important to check that the label OFF is shown on the display or that the unit is on stand-by mode. If there is an accidental start-up before the 12 hours pre-heating period has elapsed, the compressors could be seriously damaged and therefore the warranty will immediately terminate .

5.1.2 Safety device setting

Device		Set-point	Differential	Reset
Control thermostat (Heating mode)	°C	30	2	----
Anti-freeze thermostat	°C	4	4	MANUAL
High pressure switch	Bar	28,4	6	Automatic for 3 times (than manual)
Low pressure switch (HT version)	Bar	1,5	1	
Low pressure switch (LT version)	Bar	0,3	0,4	
Water safety valve (Present in A versions only)	Bar	6	---	Automatic

5.1.3 Controls during unit operation

- Check that user water inlet temperature is close to the set point of the control thermostat.
- If the pump is noisy, slowly close discharge shut-off valve until the noise is reduced to normal levels. This can occur when the system pressure drop substantially lower than the pump available pressure.

5.1.4 Refrigerant charge checking

- After several hours of operation, check that the sight glass has a green colour core: if the core is yellow moisture is present in the circuit. In this event it is necessary for dehydration of the circuit to take place. This must be performed by qualified people only. Check that there are no continuous vapour bubbles present at the sight glass. This would indicate a shortage of refrigerant. A few vapour bubbles are acceptable.

5.2 Position of the control panel



5.3 Description of the control panel

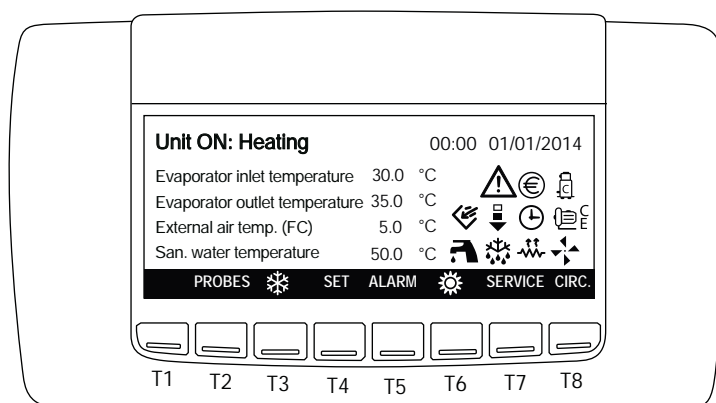

5.3.1 Display icons

Icon	Meaning	Icon	Meaning
	Number of compressors in operation.		Indicates that the electric heaters are active.
	Water pump		Economy or ON/OFF by timetable.
	Indicates that the fans are working.		Free cooling is active (not available).
	Indicates that an alarm is active.		Domestic hot water.
	Economy function		Indicates that the defrost is active.
	Unloading function.		

5.3.2 Key function

T2:	PROBES	Allows to read the value of the probes configured
T3:		Allows to switch on the unit in cooling mode
T4:	SET	Allows to read and modify the set point
T5:	ALARM	Allows to read and reset the alarms
T6:		Allows to switch on the unit in heating mode
T7:	SERVICE	Allows to enter the SERVICE menu
T8:	CIRC	Allows to read the main information of the circuits (compressor status, water pump status, pressure probe value,...)

When the unit is turned on, the display will be as follows:

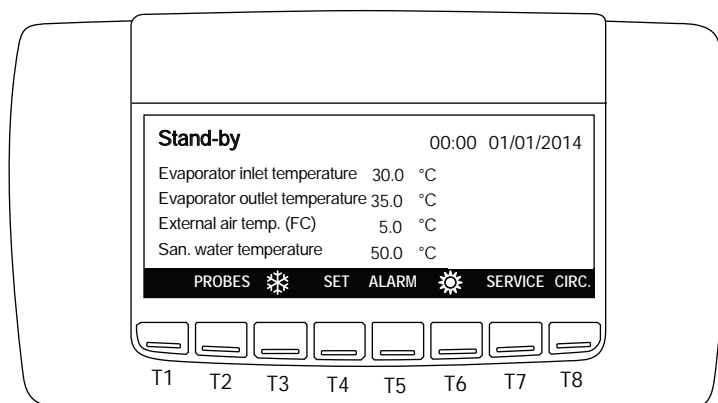

5.4 To remote the control

5.4.1 Remote keyboard connection (VGI890)

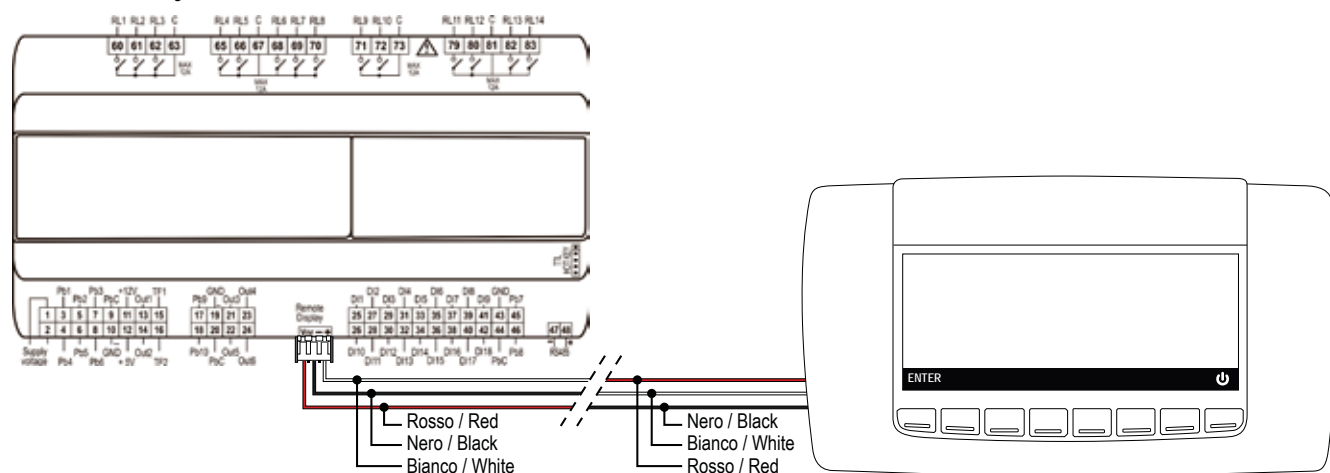

Special care must be taken when connecting the keyboard to the I chill200D, to avoid irreparable damage to the controller or/and keyboard

- In case of power supply failure (wire black or red), the keyboard doesn't work.
- In case of communication problems, the display shows "noL" message.

5.4.2 Panel mounting connection diagram

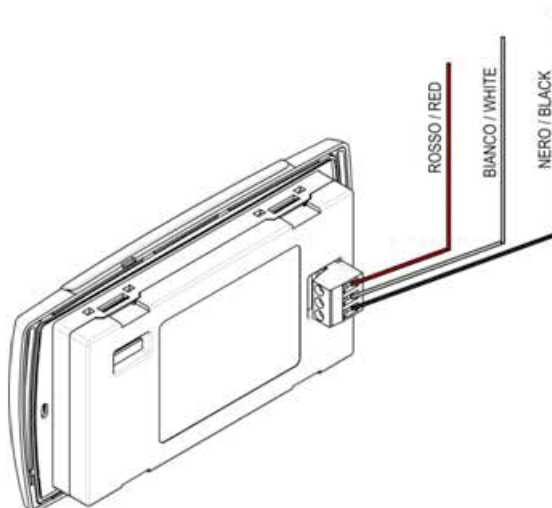

5.4.3 Wall mounting connection diagram

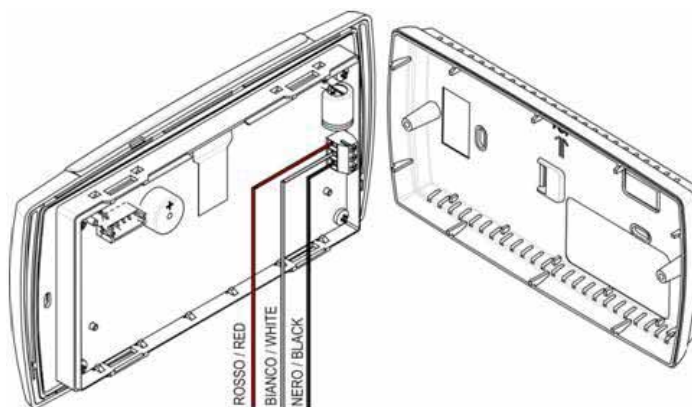

5.4.4 Selection built in display or remote keyboard

Use the selector switch as shown below to choose the desired display:

- Position 0 = display on board
- Position 1 = remote display.



For remote display electrical connections, always refer to the electrical diagram supplied with the unit.

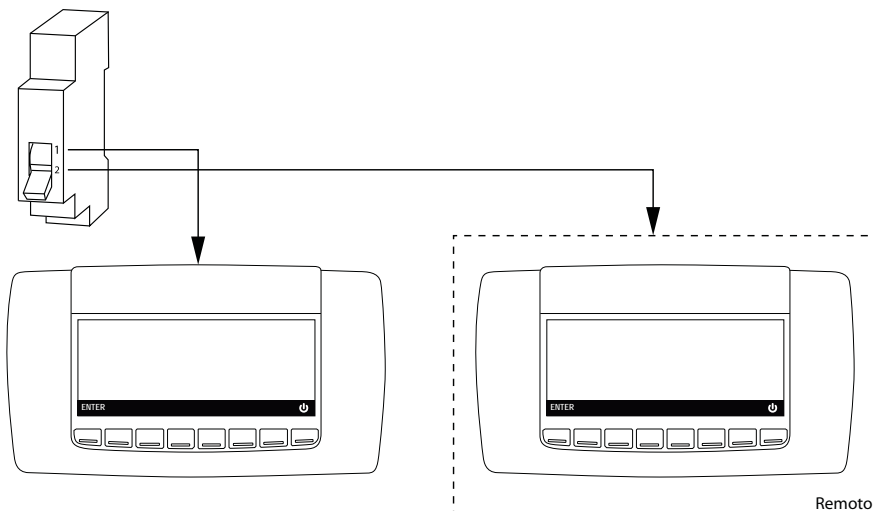

6. USE

6.1 Switch the unit on

Unit switch-on and switch-off can take place:

- From the keyboard
- From digital input configured as remote ON/OFF



Before first start-up, consult and carry out the operations described in the paragraph “ Periodical checks “.

6.1.1 Switch the unit on from the keyboard

Heating mode

To start the unit in heating mode, press the  key. The icon  appears on the display.

If requested, the compressor safety delay countdown starts and the compressor icon flashes. The water pump will be activated after few seconds and then, once the compressor countdown has finished, the compressor starts and the icon remains on. The display shows the user water inlet temperature.

In stand-by mode, the controller gives the possibility to:

- display the set values
- manage alarms, their display and reports.



If it is required to switch the unit on and off, never do this using the main isolator: this should only be used to disconnect the unit from the power supply when the unit is to be permanently off. Isolation will result in no supply for the crankcase heater and on start up the compressor could be seriously damaged.

6.1.2 Heating and cooling mode

The display shows the typical visualization during the unit working in:

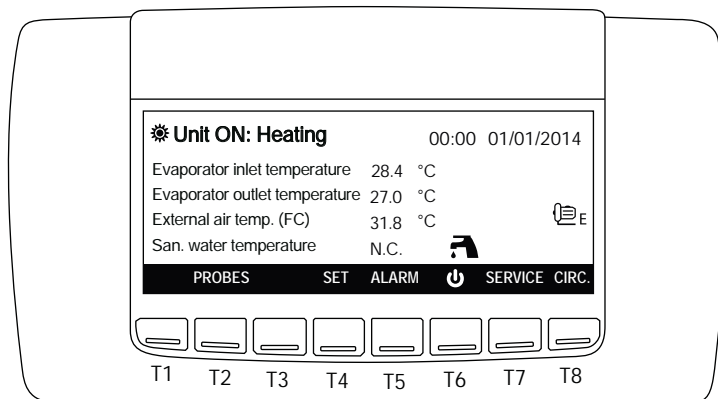

6.1.3 Switch the unit on from from digital input

If the unit is switch off by remote digital input, the display shows:

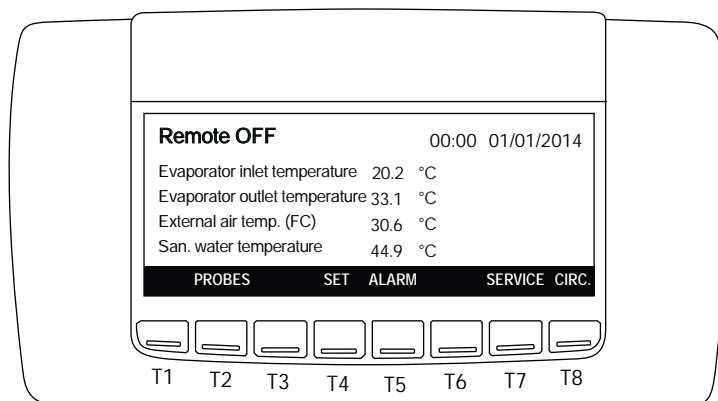

When the digital input is not active, the unit is in OFF mode

- The remote input has the priority with respect to the keyboard
- The unit can only be switched-on and off if the remote input is activated

6.2 Stop

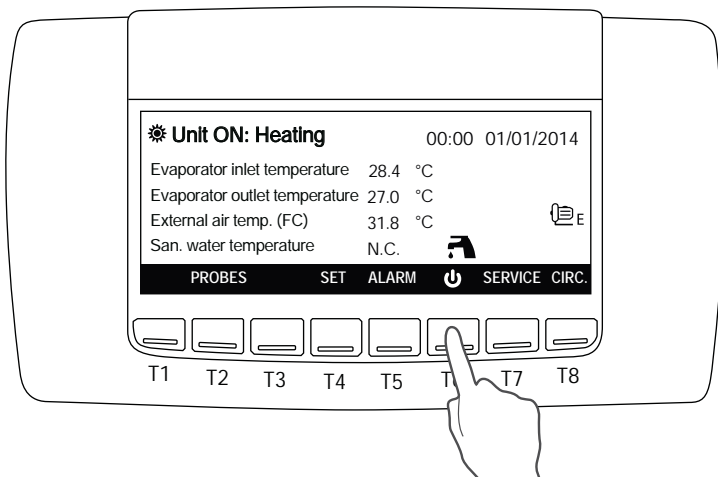

To switch the unit off press the key .

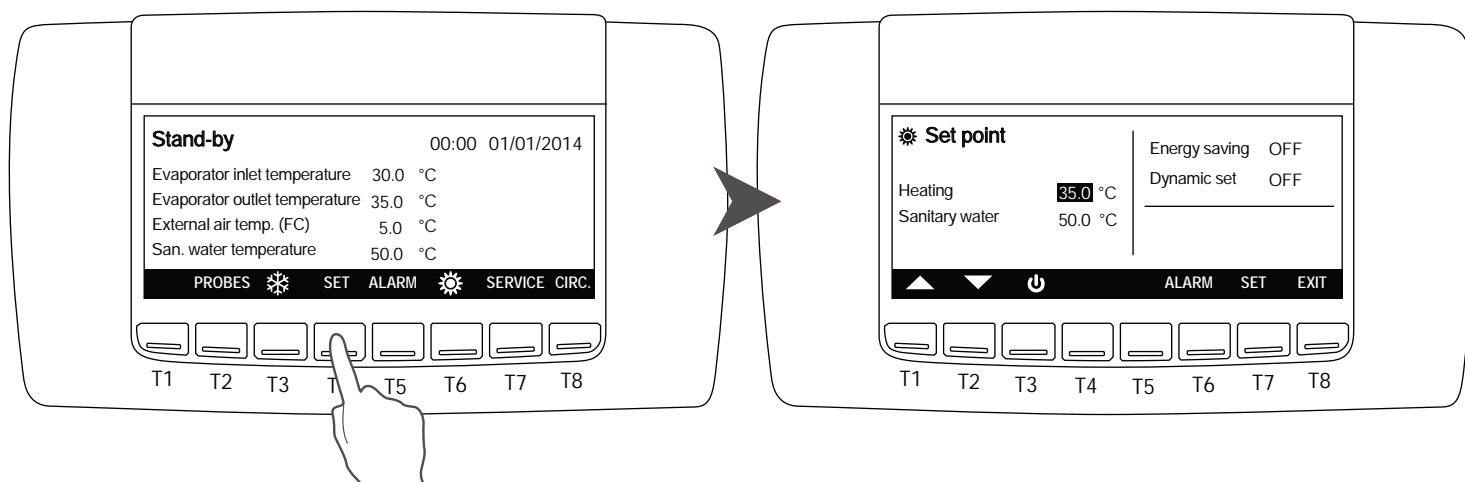

6.3 Set point

To change the set-point from the main screen, press **SET** .



To modify the values, move the cursor with ; press **SET** to select, the value starts blinking, change the data pressing  and . Once the required value is reached, press again **SET** to confirm.

The cursor will automatically position itself on the next value, to modify it, repeat the operation just described.

In this screen it is also possible to verify (but not modify) whether the energy saving mode and dynamic set are active.

Press **EXIT** to go back to the main menu.



All set points refer to the return temperature from the plant. In case hot water at 45°C is requested and the Δt is 5°C, then the set point must be set at 40°C. In case the Δt is 8°C, then the set point must be set at 37°C. In case cold water is requested, for example at 15°C and the Δt is 5°C, then the set point must be set at 20°C. If the Δt is 8°C, then the set point must be set at 23°C.

6.3.1 Adjustable parameters

The adjustable set point that can be modified by the end user are:

Function	Adjustment limit	Default value
Heating set-point	10÷55°C	35°C
Set point compensation	0÷15°C	10°C
Password	(Contact the company)	



The units are supplied with a very sophisticated control system with many other parameters that are not adjustable by the end user; these parameters are protected by a manufacturer password.

6.4 PROBES key

To view all the parameters measured by the sensors of the unit press **PROBES** ;

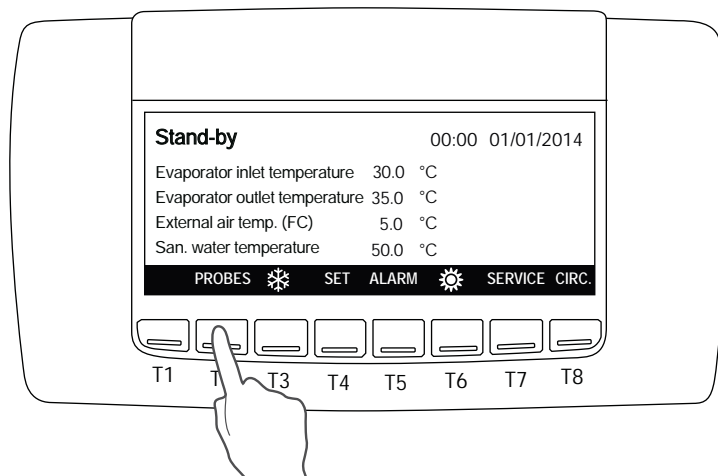

By pressing the key, all relevant values of the circuit will be displayed

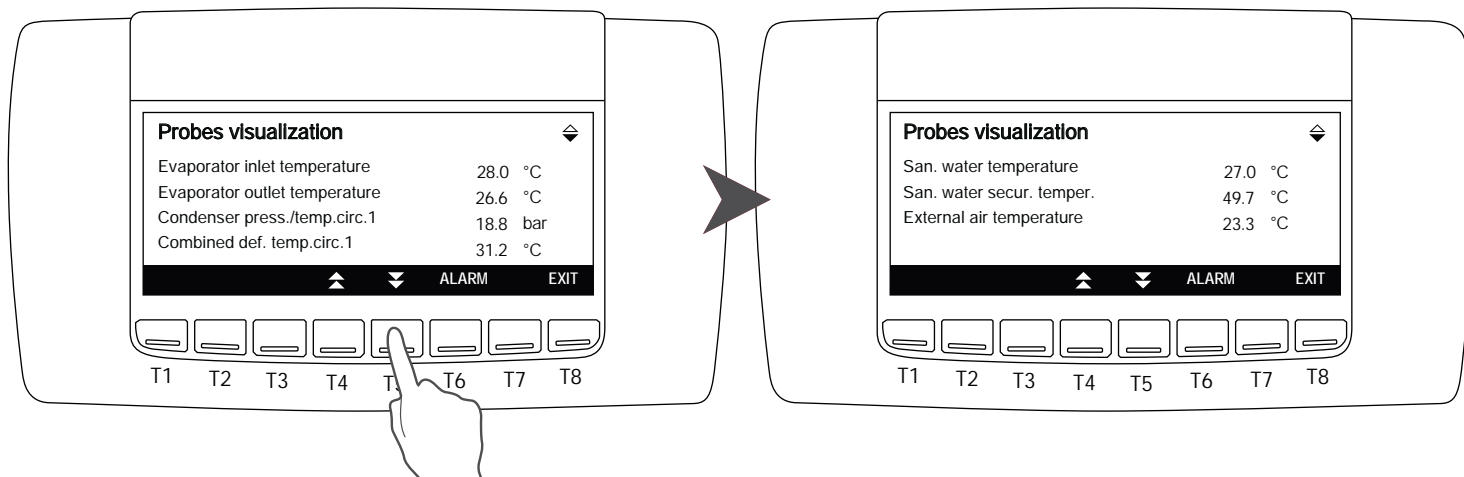

Press **EXIT** to go back to the main menu.

6.5 ALARM key

When the alarm occurs, the display shows the icon blinking.

Press **ALARM** key to read the alarm status:

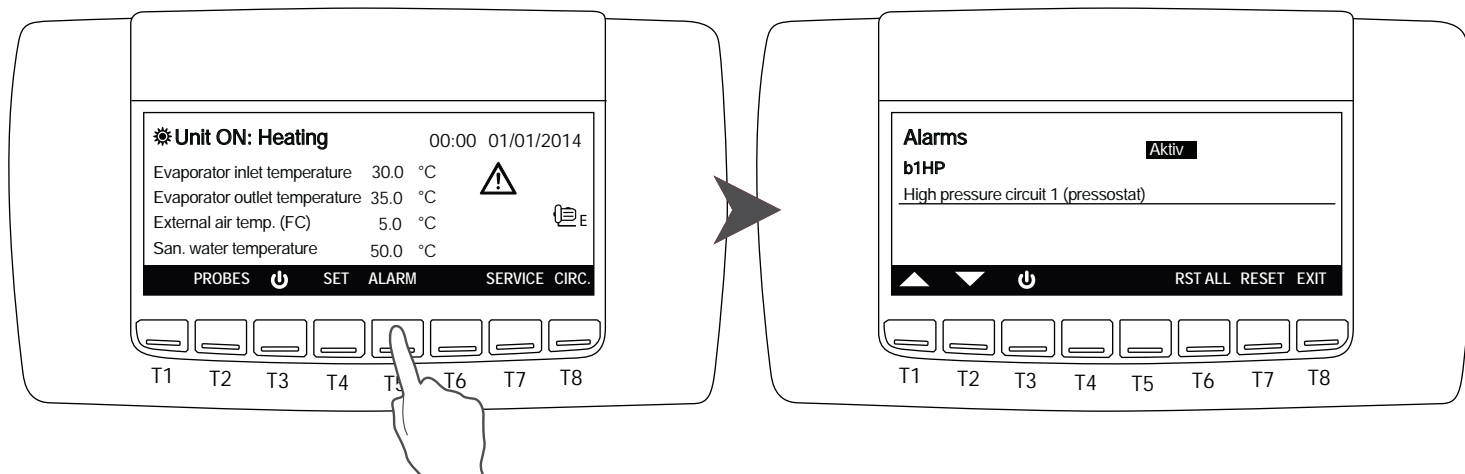

The alarm status can be:

- **Reset:** the alarm is not active and it is possible to reset it. Press and keys to select the alarm to select it and press **RESET** key to reset the alarm.
- **Password:** in this case the alarm is no longer active, but you need a password to reset it (please contact the Company).
- **Active:** the alarm is still active and it is not possible to reset it.

In case more resettable alarms are present, it's possible to reset all of them at once pressing **RST ALL** key. In any case, even if all the alarms are reset, they remain present in the alarm history (par. 6.7.7).

6.6 CIRC key

Pressing **CIRC** can view the different parameters of the unit:

Pressing and you move from one screen to another while with and you scroll through the menu items. Press **ENTER** key to view the values.

State of the compressors; the display shows compressors present in each circuit and the activation status of each one.

Color black: compressor running

Color white: compressor on standby

In case of use of compressors in part-loading (typically screw compressors) an icon appears to the right of the compressor showing the level of step control.

In case of use of On/Off compressors (Scroll) no icon appear to the right of the compressor.

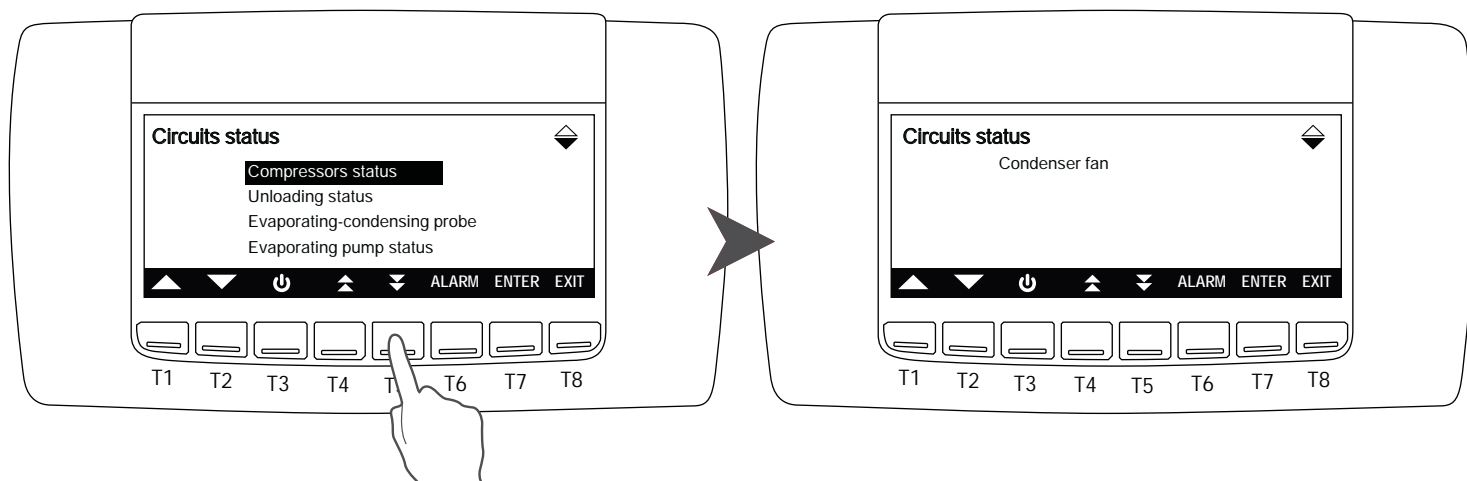
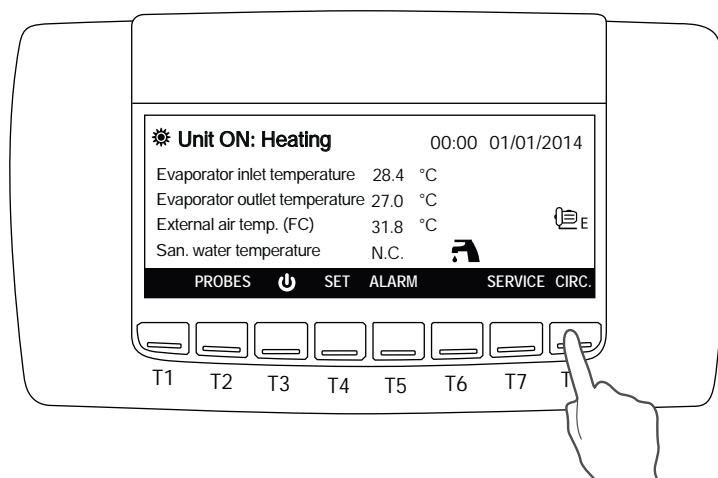

Compressor status

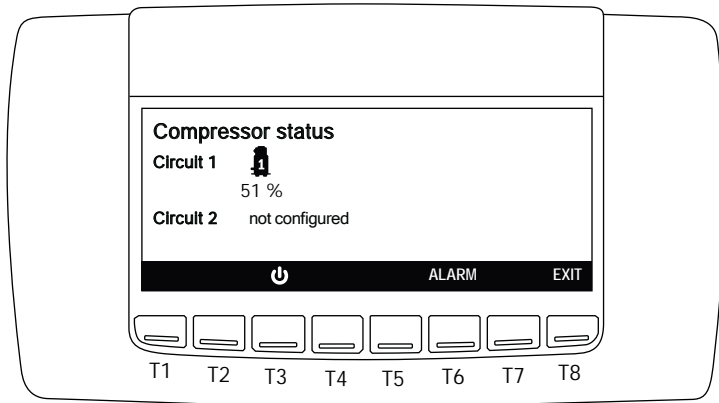

Unloading status

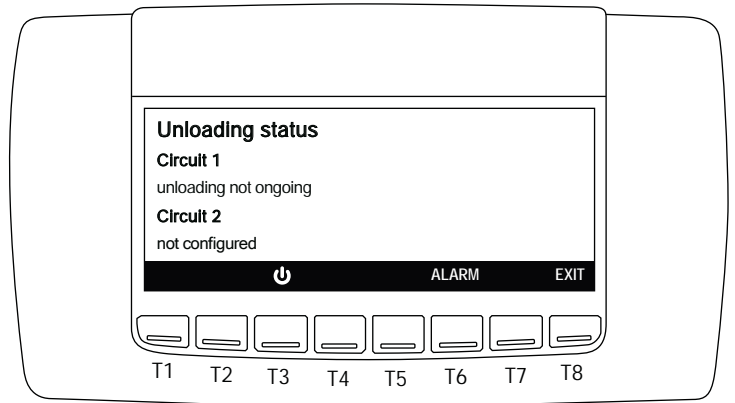

Evaporating-condensing probe

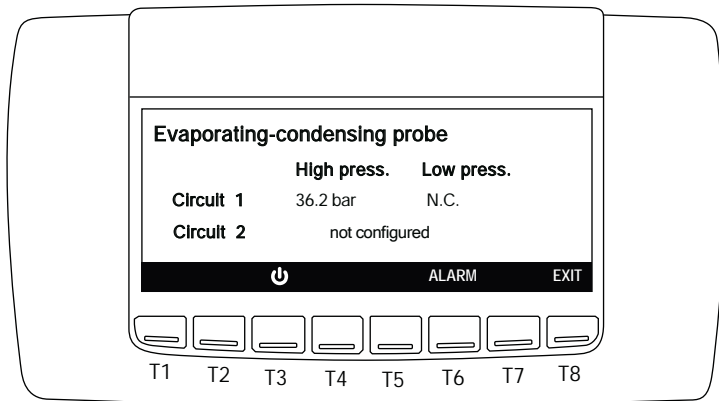

Evaporator pump status

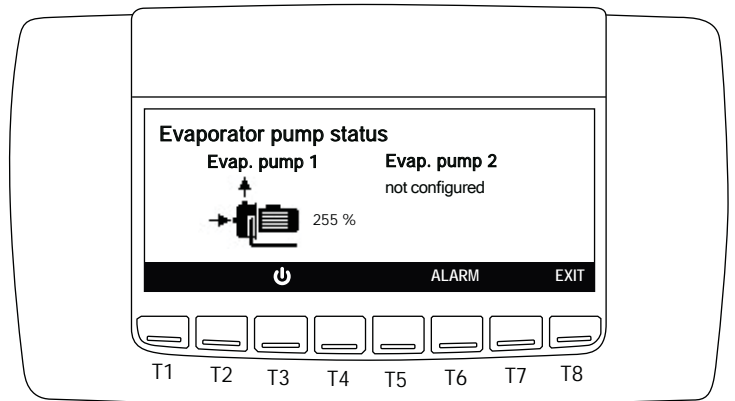

Condenser fan

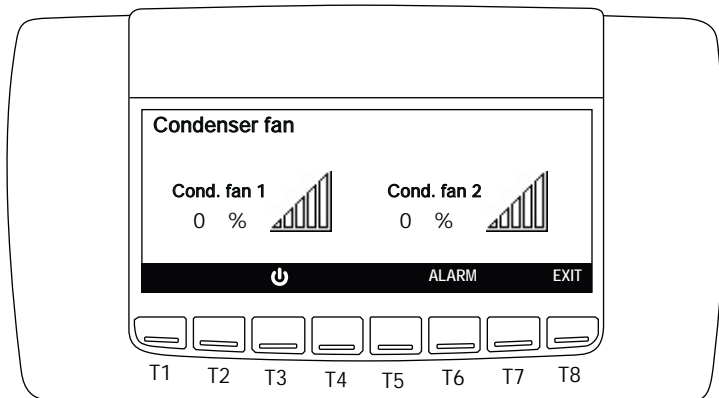

6.7 SERVICE key

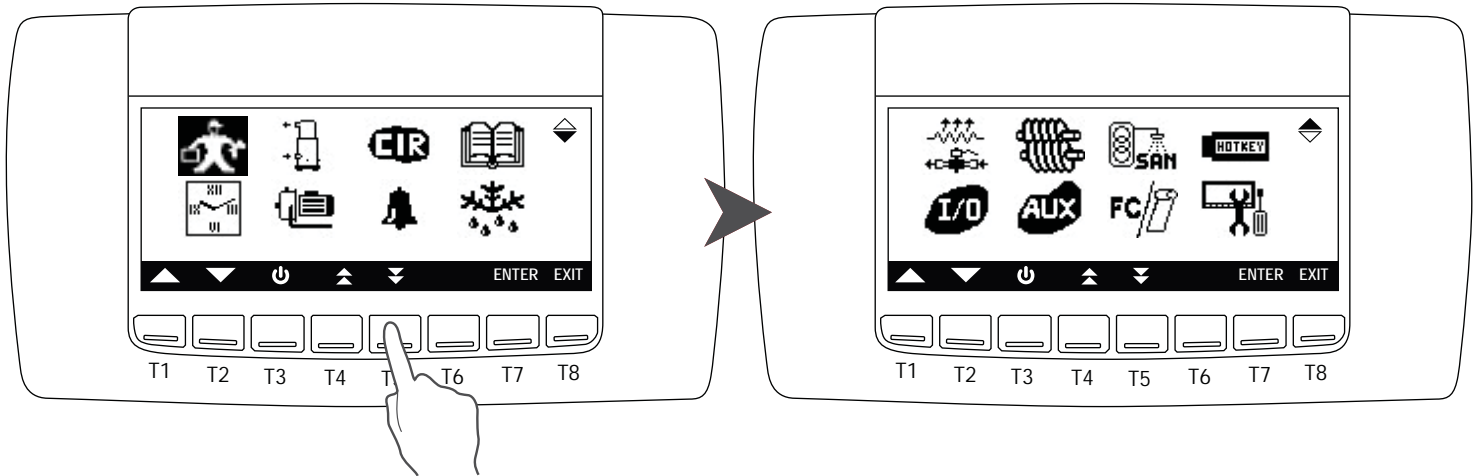

Press the **SERVICE** key to access the following menus:

	Setting parameters (for service only)		Electrical heater and pump down valve status
	Time and date setting		I/O status (Inputs and Outputs)
	Compressors status		Screw compressor information (Not configured)
	Pumps		Auxiliary outputs
	Circuit maintenance		Domestic hot water (if available)
	Display of alarms		Free cooling and Solar panel visualization (if available)
	Alarm history		Upload and download parameter map with Hot Key
	Defrost (if available)		Control panel

Press key to display all the menu available.

To modify and set the parameters move the cursor using the and , press **ENTER**, to select the required menu, and then **SET** to select the desired value.

Change the parameters by pressing the and , and then press **SET** again to confirm.

Press the **EXIT** key to return to the main menu.

6.7.1 Service parameters setting

To enter service menu select  moving between the icons with T1 and T2 keys and press T7.

The system prompts you to enter the password to access to different levels of security.

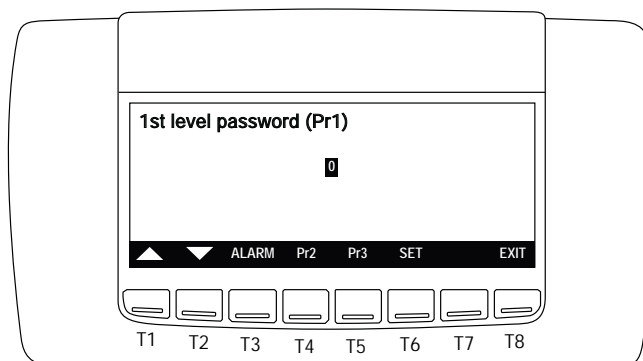

The first level allow to modify some parameters as for example heating and cooling set points and dynamic set points. Press T6 key, with T1 modify the password to 1 then press T6 again to confirm.

The display show:

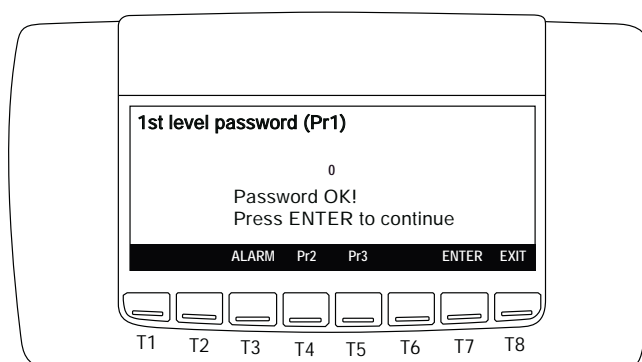

Press T1 and T2 to scroll through different groups of parameters. With password level 1 you could only change the Set Point (St), dynamic Set point (Sd), parameters of sanitary circuit (FS) and parameters for setting the time bands (ES); the unit must be switched on. Press T7 to enter in the group of parameters. Other parameters can only be modified by service with a dedicated password. Other parameters could be modified by service people only with a dedicated password.

Parameters list:

Code	Meaning	Code	Meaning
St	Set point	US	Auxiliary output
dP	Main visualization	FA	Fan
CF	Configuration	Ar	Antifreeze
Sd	Dynamic set	dF	Defrost
ES	Energy saving	FS	Sanitary water
Cr	Compressor racks	AL	Alarms
CO	Compressor		

To modify the value of the parameter: press or to select the parameter to modify then press **SET** the value start to blinking, press and to modify, than press **SET** again to confirm.

The values available in the group of parameters “Set point” (St) are: summer set point (St01), winter set point (St04), summer regulation band (St07) and winter regulation band (St08).

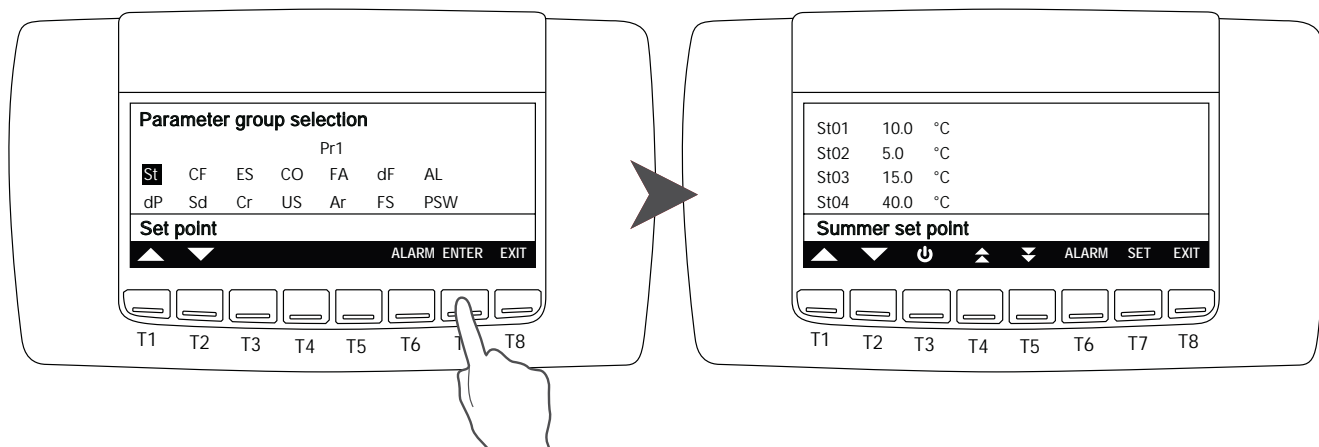

The values available in the group of parameters “Dynamic set point” (Sd) are: dynamic set point: summer offset (Sd01), dynamic set point: winter offset (Sd02), dynamic set point: summer outside temp. (Sd03), dynamic set point: winter outside temp. (Sd04), dynamic set point: summer differential temp. (Sd05) and dynamic set point: winter differential temp.(Sd06).

For more informations about the parameters see par. 6.3.1 and 6.3.2.

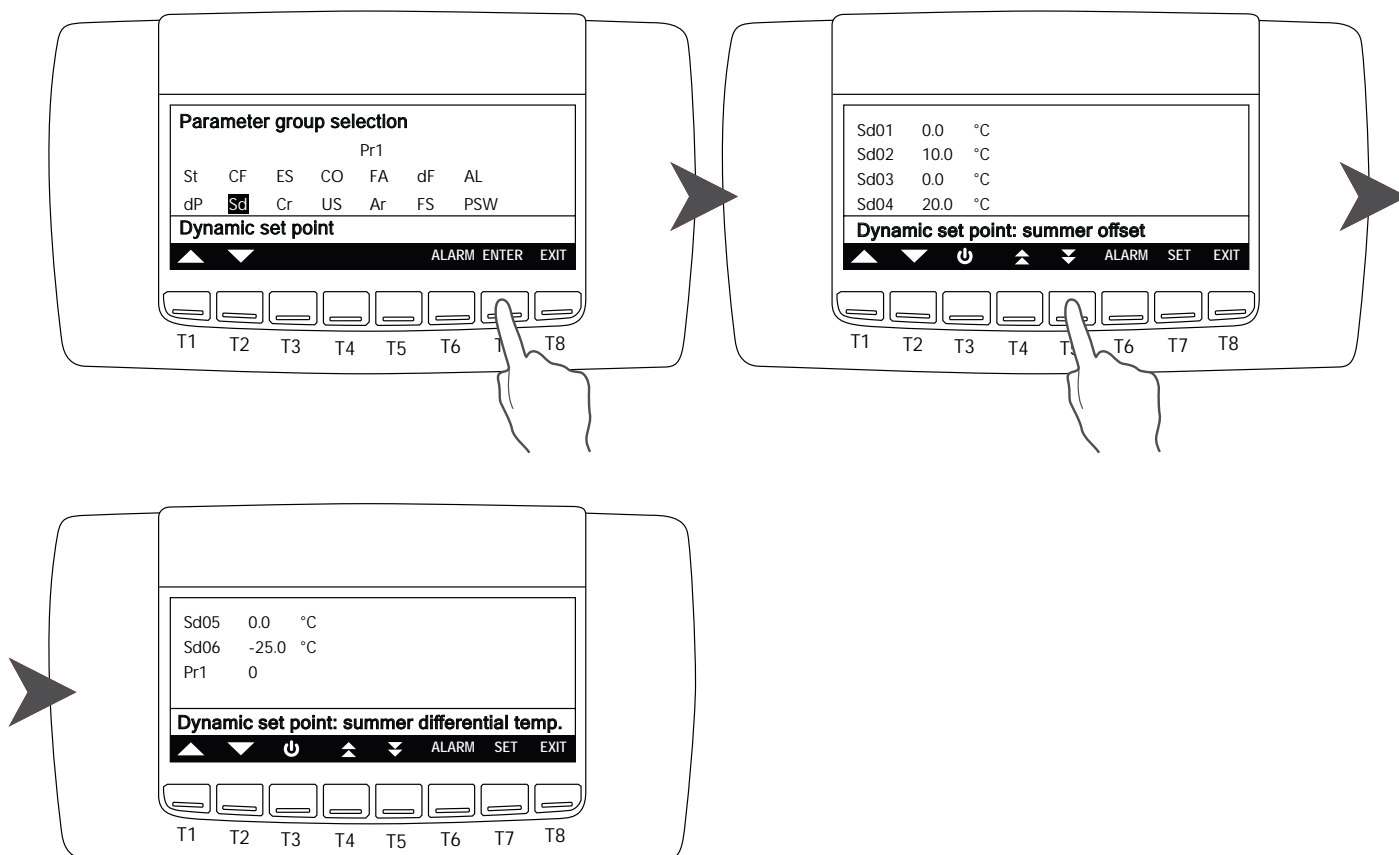

Weather compensated function

This function makes it possible to activate the weather compensation sensor in order to optimize the efficiency of the unit. Automatically it modifies the set-point value with respect to external air temperature: a calculation is performed on the set-point to provide a revised value of set point for higher ambient conditions (see example given below). This function makes it possible to save energy and to operate the unit in severe ambient conditions. This function is only active in heating mode.

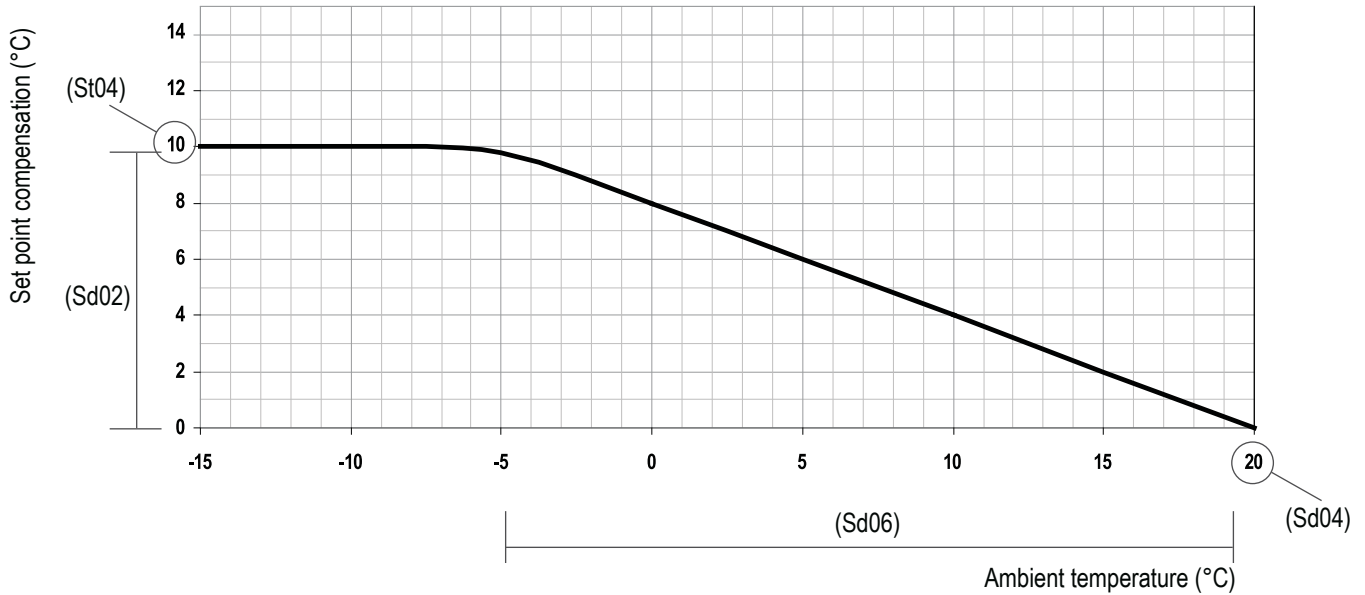

All units are factory set with the weather compensated function activated. The slope starts at +20°C with a differential of 10°C.



With the energy saving mode activated, if the SET key is pressed twice the bottom of the display shows the SETTR (weather compensated set point) label that is the specific set point calculated by the microprocessor control for the measured ambient temperature condition.

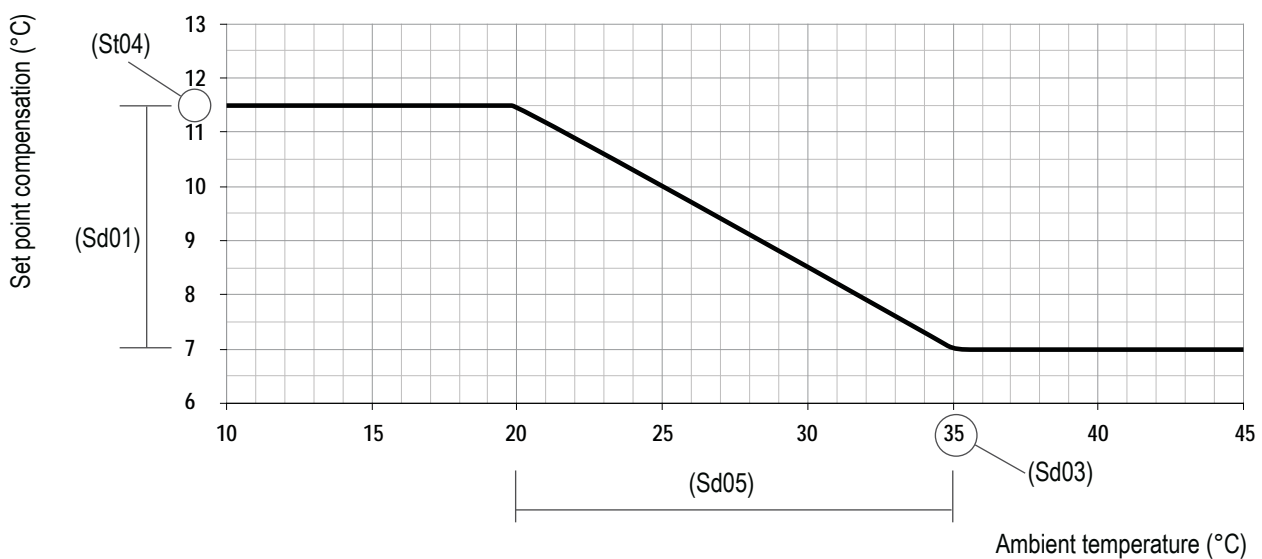

The values available in the group of parameters “Sanitary circuit” (FS) are: Sanitary water priority (FS02), Sanitary water set point (FS03), Sanitary water proportional band (FS04) .

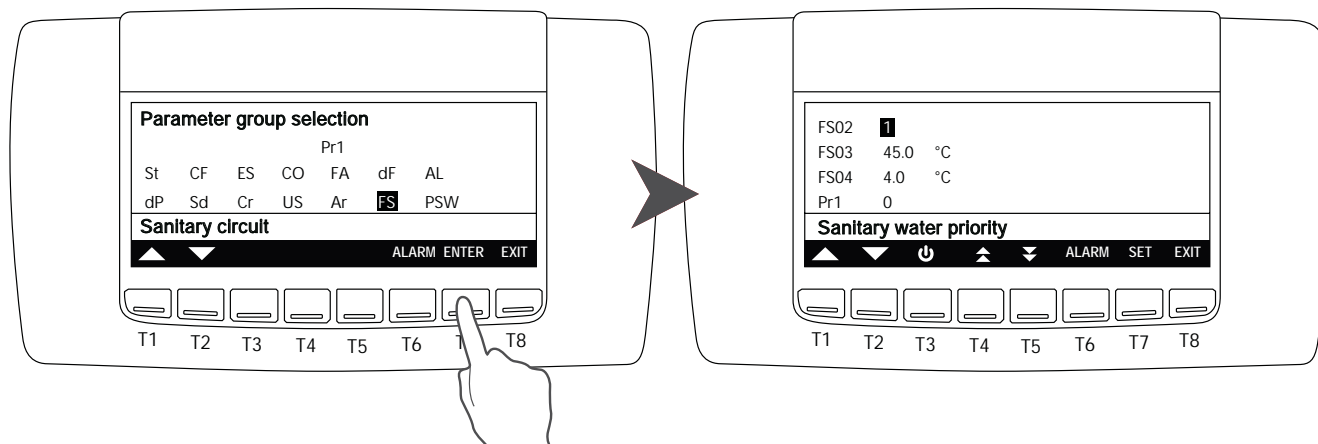

6.7.2 Time bands setting

To access the group of parameters for setting the time bands, select ES

ES01	Start of operating range N°1 (0÷24)	ES17	Differential energy saving set in heat pump operation
ES02	End of operating range N°1 (0÷24)	ES18	Maximum unit operating time in OFF by RTC if forced into ON by button
ES03	Start of operating range N°2 (0÷24)	ES19	Time band 1 DHW: start
ES04	End of operating range N°2 (0÷24)	ES20	Time band 1 DHW: end
ES05	Start of operating range N°3 (0÷24)	ES21	Time band 2 DHW: start
ES06	End of operating range N°3 (0÷24)	ES22	Time band 2 DHW: end
ES07	Monday with energy saving time band Monday operation with automatic on/off	ES23	Time band 3 DHW: start
ES08	Tuesday with energy saving time band Tuesday operation with automatic on/off	ES24	Time band 3 DHW: end
ES09	Wednesday with energy saving time band Wednesday operation with automatic on/off	ES25	Monday: time band selection
ES10	Thursday with energy saving time band Thursday operation with automatic on/off	ES26	Tuesday: time band selection
ES11	Friday with energy saving time band Friday operation with automatic on/off	ES27	Wednesday: time band selection
ES12	Saturday with energy saving time band Saturday operation with automatic on/off	ES28	Thursday: time band selection
ES13	Sunday with energy saving time band Sunday operation with automatic on/off	ES29	Friday: time band selection
ES14	Increased energy saving set in chiller operation	ES30	Saturday: time band selection
ES15	Differential energy saving set in chiller operation	ES31	Sunday: time band selection
ES16	Increased energy saving set in heat pump operation	ES32	Energy saving: offset DHW setpoint

Sets of time bands that can be set on different days of the week are:

- 0 = None
- 1 = Time band 1
- 2 = Time band 2
- 3 = Time bands 1 and 2
- 4 = Time band 3
- 5 = Time bands 1 and 3
- 6 = Time bands 2 and 3
- 7 = All time bands

Operating modes

The possible operating modes are:

- **Automatic ON-OFF:** automatic switching on and off of the unit according to set times.
- **Energy Saving:** Allows you to set two different set points, for example one for the day and one for the night.

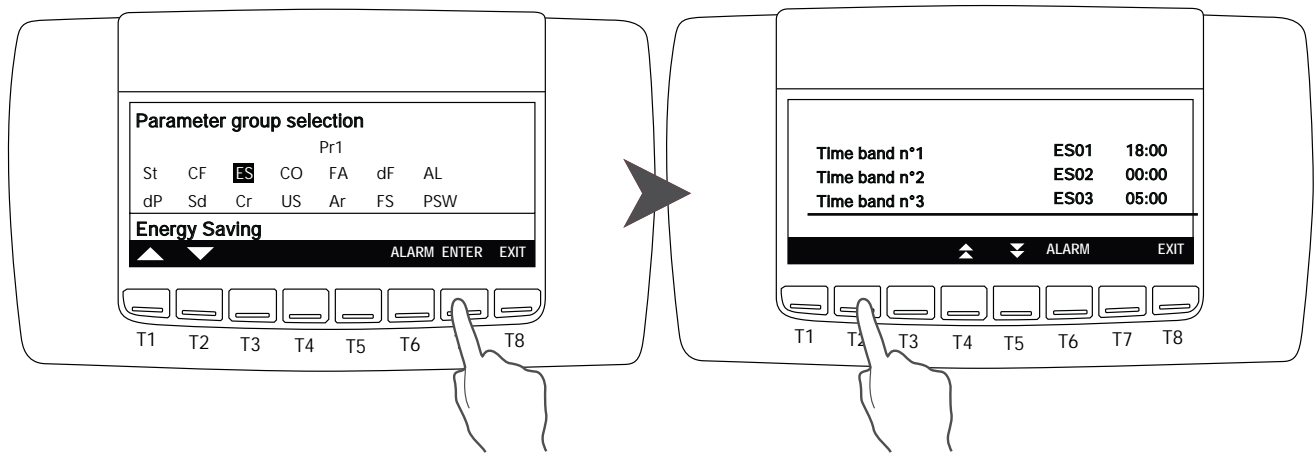

Up to three time bands can be set.

Select the time to be changed by moving with T1 and T2 keys confirm the parameter select with T7 key than change the values with T1 and T2 keys.

Press T5 key to view all available parameters.

6.7.3 Setting date and time

To enter this menu select  moving between the icons with the keys T1 and T2 and press T7.

Press T1 and T2 to select the value you want to edit than press T7. The selected parameter will start blinking, press T1 and T2 to set the value and than press T7 to confirm.

Pressing T5 it is possible to read the information about the Energy saving, ON/OFF scheduling and time bands. To modify the hour of the time band and to enable the function is necessary to insert the password, in case you do not have a password, you can only view the different parameters..

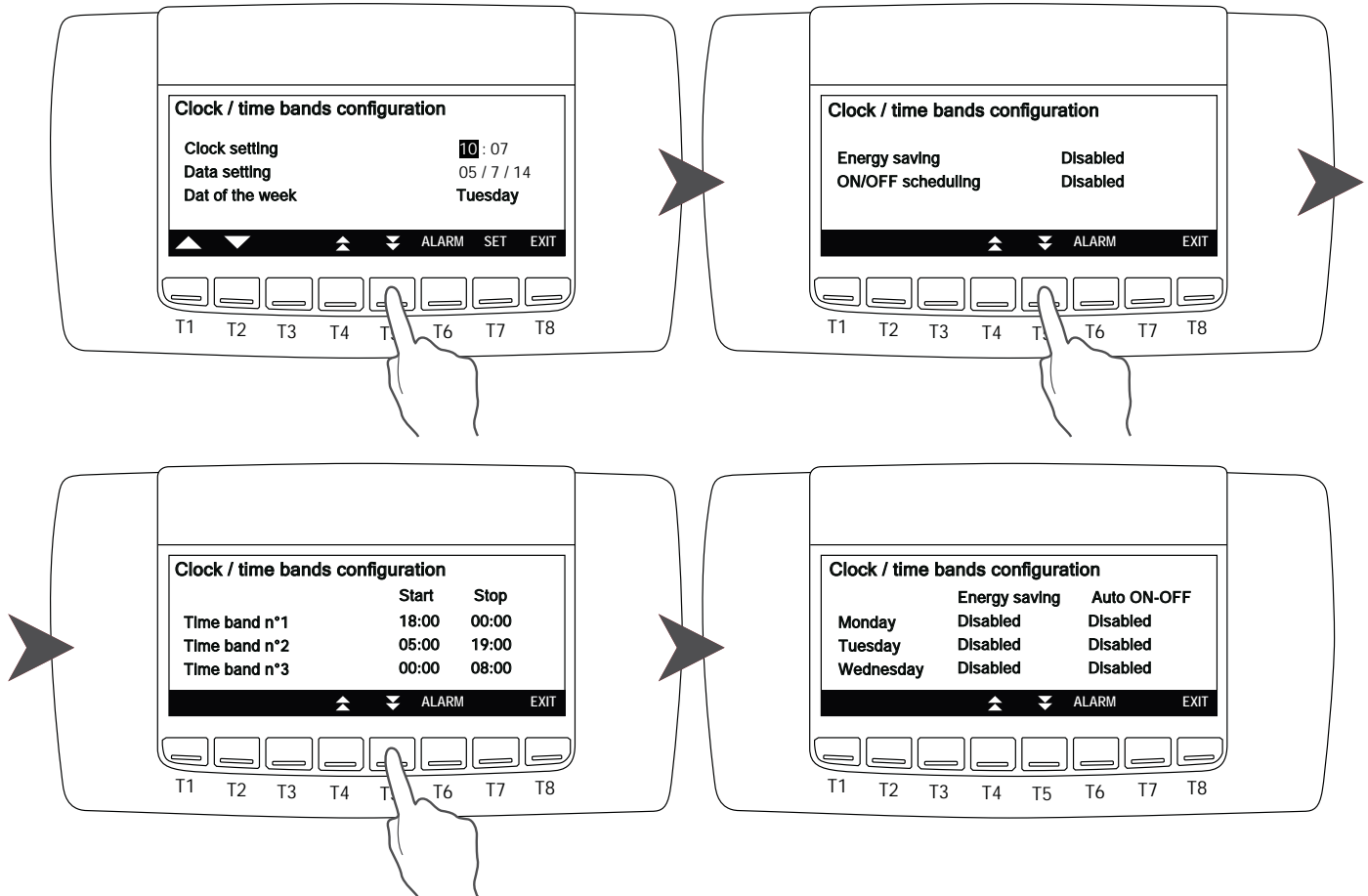

6.7.4 Compressor maintenance



To enter this menu select  moving between the icons with the keys T1 and T2 and press T7.

It is possible to display the compressors working hour and the number of activations. Select the circuit with the keys T1 and T2 than press T7 to display the parameters. The disabling function of the compressors T7 is only possible by service people.

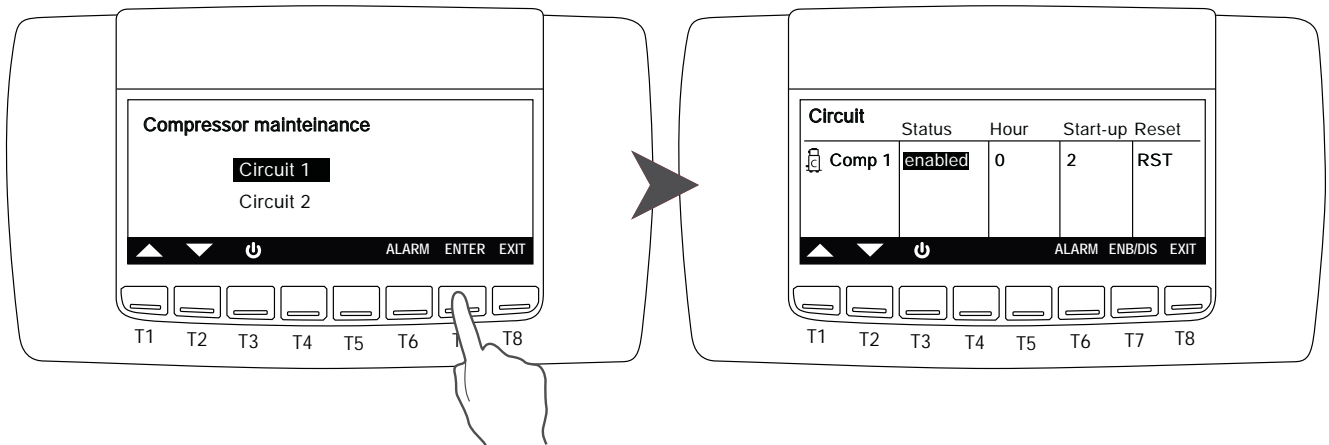

6.7.5 Water pumps



To enter this menu select  moving between the icons with the keys T1 and T2 and press T7.

It is possible to display the working hours of water pumps. The function T7 is only possible by service people.

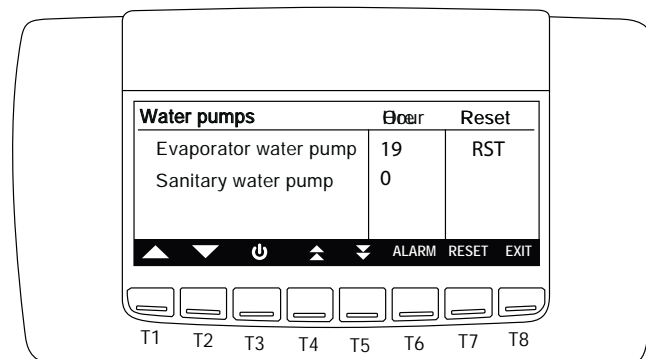

6.7.6 Circuit maintenance



To enter this menu select  moving between the icons with the keys T1 and T2 and press T7.

It is possible to display the status of the circuits. The function T7 is only possible by service people.

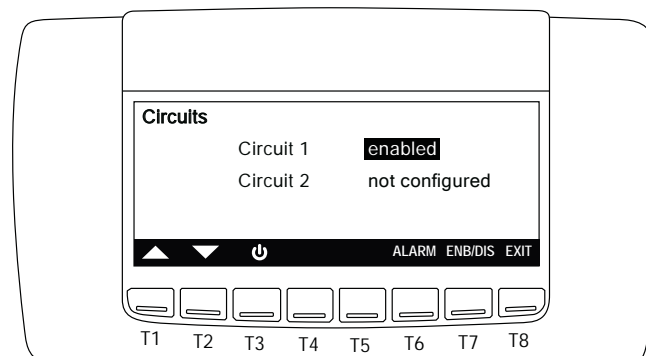

6.7.7 Alarms

To enter this menu select  moving between the icons with the keys T1 and T2 and press T7.

For the management of alarms see par. 6.5.

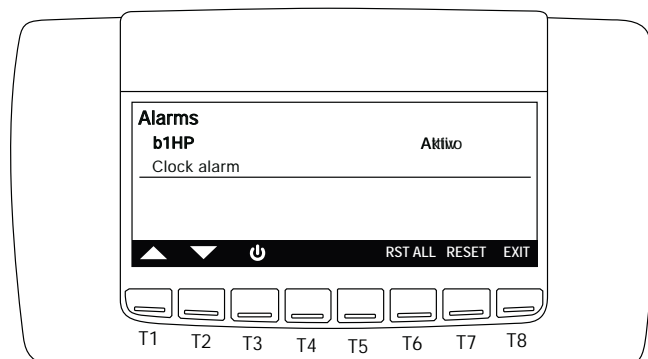

6.7.8 Alarm log

To enter this menu select  moving between the icons with the keys T1 and T2 and press T7.

Pressing T4 and T5 it is possible to read the last 99 alarms. The function of reset of all alarms T7 is only possible by service people.

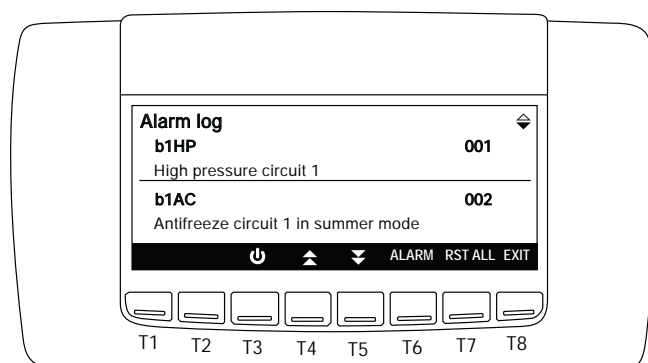

6.7.9 Defrost

To enter this menu select  moving between the icons with the keys T1 and T2 and press T7.

For each circuit it is possible to read the status of the defrost and, after selecting the circuit, pressing the T7 key it is possible to display some parameters relating to the defrosting of the circuit (values related to the probes and to the set points).

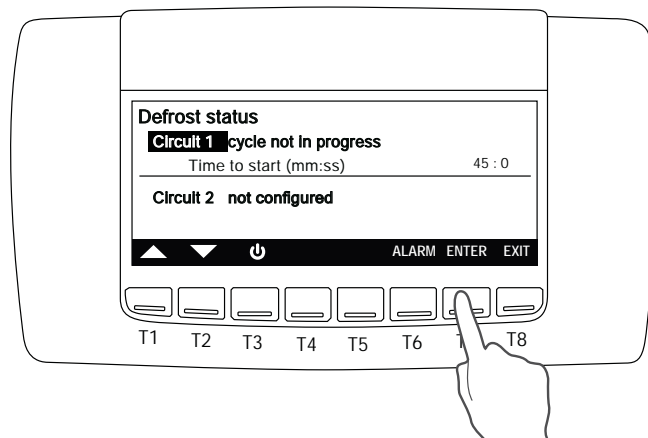

Press T4 and T5 to display all the available parameters.

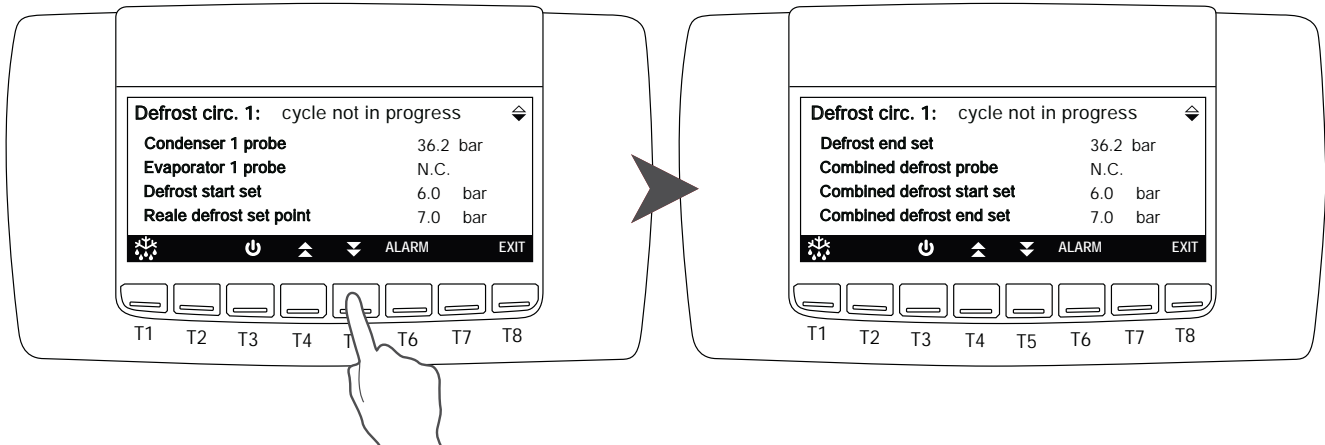

6.7.10 Eletrical heater



To enter this menu select  moving between the icons with the keys T1 and T2 and press T7. It is possible to read the status of the electrical heaters.

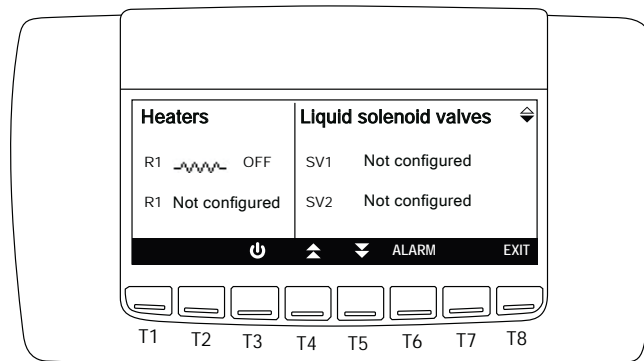

6.7.11 I/O Status (Input/Output)



To enter this menu select  moving between the icons with the keys T1 and T2 and press T7. It is possible to display: probes status, analog input and output, digital input and output.

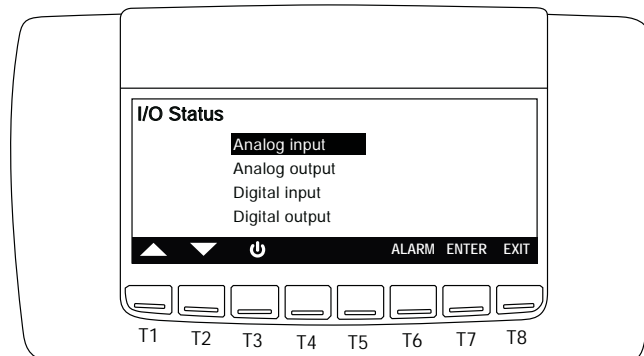

6.7.12 Screw compressor (If available)



To enter this menu select  moving between the icons with the keys T1 and T2 and press T7.
 In the main screen it is possible to display the discharge temperature and the liquid injection set point. Press T4 and T5 keys to select the required circuit than press T7 key to read the discharge temperature and the status of the valves.

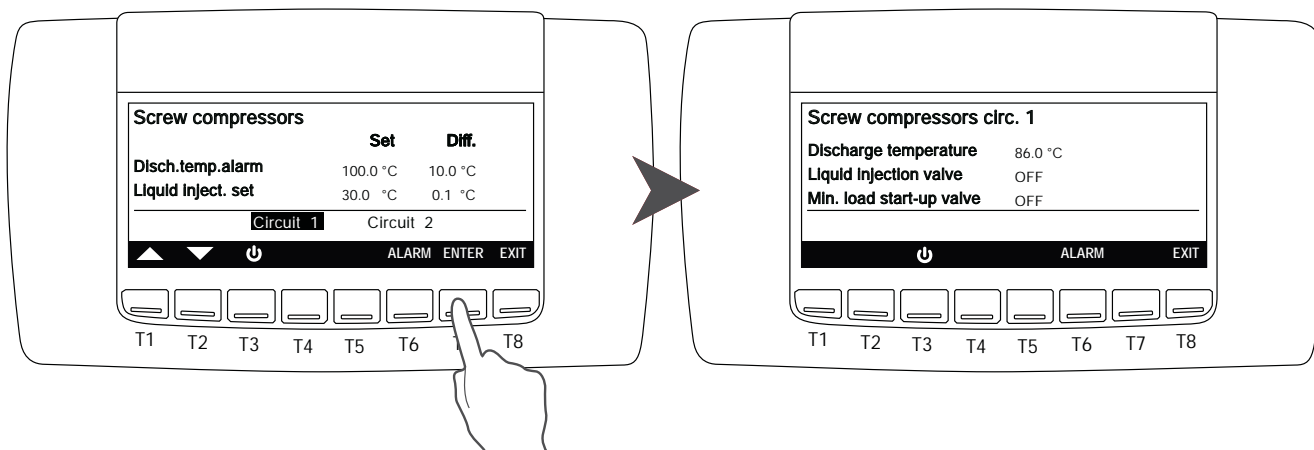

6.7.13 Auxiliary output



To enter this menu select  moving between the icons with the keys T1 and T2 and press T7.
 It is possible to read informations about auxiliary outputs.

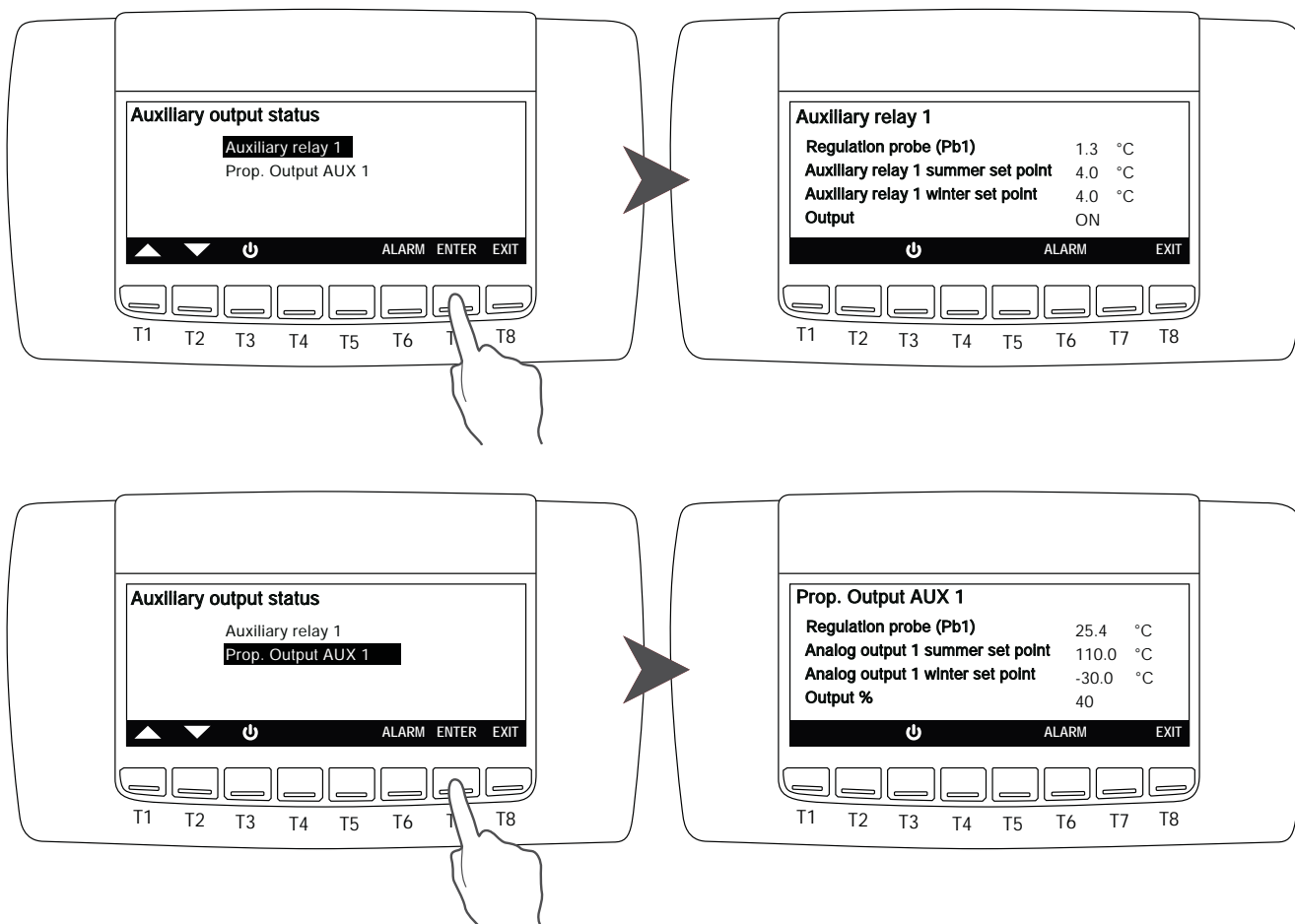

6.7.14 Sanitary water



To enter this menu select **SAN** moving between the icons with the keys T1 and T2 and press T7.
 It is possible to read informations of the sanitary water regulation. Press T7 key to modify the values.

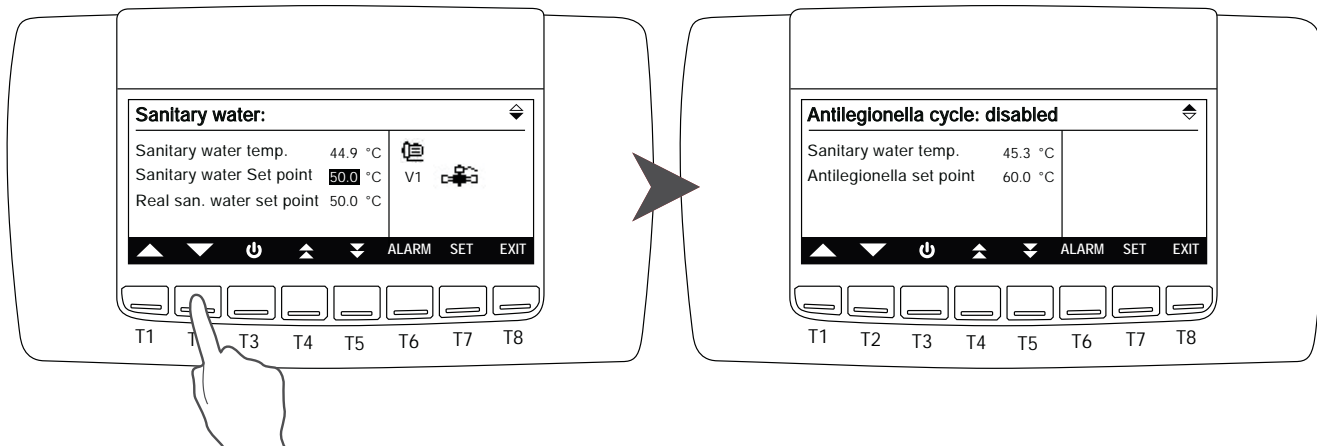

6.7.15 Upload / download



To enter this menu select **HOTKEY** moving between the icons with the keys T1 and T2 and press T7.
 This function is allowed only to the service.

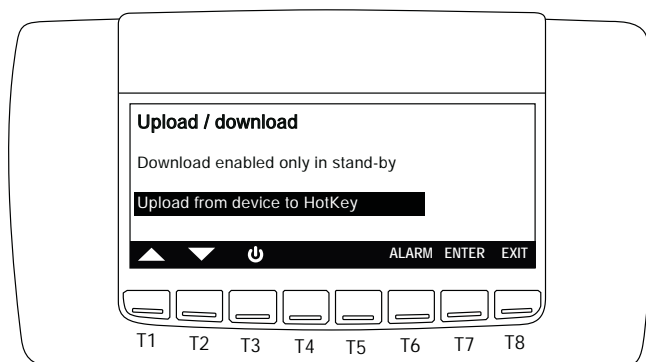

6.7.16 Control panel



To enter this menu select **Control panel** moving between the icons with the keys T1 and T2 and press T7.

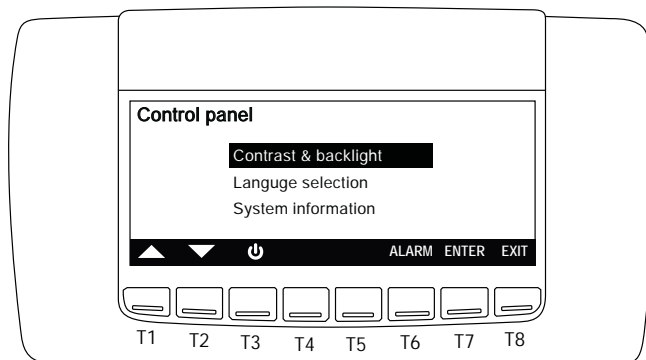

6.8 Acoustic signal silencing

Pressing and releasing one of the keys; the buzzer is switched off, even if the alarm condition remains in place.

6.9 Emergency Stop

The emergency stop gives the possibility to stop the unit for the minimum possible time.

If an emergency stop is required, follows this procedure:

- Turn the main switch (red and yellow) OFF; the unit immediately stops.

6.9.1 Start after an emergency stop



Before restarting the unit, verify that the cause of the emergency stop has been eliminated

Restarting the unit proceeding as follows:

Turn the main switch ON.

7. MAINTENANCE OF THE UNIT

7.1 General warnings



Starting from 01/01/2016 the new European Regulation 517_2014, "Obligations concerning the containment, use, recovery and destruction of fluorinated greenhouse gases used in stationary refrigeration, air conditioning and heat pumps", became effective. This unit is subject to the following regulatory obligations, which have to be fulfilled by all operators:

- (a) Keeping the equipment records
- (b) Correct installation, maintenance and repair of equipment
- (c) Leakage control
- (d) Refrigerant recovery and disposal management
- (e) Presentation to the Ministry of the Environment of the annual declaration concerning the atmospheric emissions of fluorinated greenhouse gases.

Maintenance can:

- Keep the equipment operating efficiently
- Prevent failures
- Increase the equipment life



It is advisable to maintain a record book for the unit which details all operations performed on the unit as this will facilitate troubleshooting.



Maintenance must be performed in compliance with all requirements of the previous paragraphs.



Use personal protective equipment required by regulations as compressor casings and discharge pipes are at high temperatures. Coil fins are sharp and present a cutting hazard.



If the unit is not to be used during the winter period, the water contained in the pipes may freeze and cause serious damage. In this event, fully drain the water from the pipes, checking that all parts of the circuit are empty including any internal or external traps and siphons.



If it is necessary to replace a component of the machine, both for ordinary and extraordinary maintenance, this component must have the same or higher characteristics than those present. The same or higher performances or thicknesses are meant for the characteristics, which do not compromise the safety, the use, the handling, the storage, the pressures and the temperatures of use of the machine provided by the manufacturer.



The taps in the machine must always be in open position before starting. If it is necessary to disconnect the refrigeration circuit by closing the taps, it is necessary to take precautions to prevent the unit from starting up, even accidentally, and to indicate that the taps have been properly closed with special signs, both on the tap and in the electrical panel. In any case, the taps must remain closed as less as possible.

7.2 Drive access

Access to the unit once installed, should only be possible to authorized operators and technicians. The owner of the equipment is the company legal representative, entity or person owns the property where the machine is installed.

They are fully responsible for all safety rules given in this manual and regulations. If it is not possible to prevent access to the machine by outsiders, a fenced area around the machine at least 1.5 meters away from external surfaces in which operators and technicians only can operate, must be provided.

7.3 Scheduled maintenance

The owner must make sure that the unit is periodically inspected, also on-site, adequately maintained, according to the type, size, age and use of the system, and to the indications contained in the Manual.

Servicing during the unit's operating lifetime and, in particular, scheduled leak detection, on-site inspections and check-ups of safety equipment, must be carried out as provided by local laws and regulations in force.



If leak detection instruments are installed on the system, they must be inspected at least once a year, to make sure that they work properly.

During its operating life, the unit shall be inspected and verified in accordance with applicable local laws and regulations. In particular, when there are no stricter specifications, the indications given in the following table (see EN 378-4, Annex D) must be followed, with reference to the situations described.

CASE	Visual Inspection	Pressure Test	Search for leaks
A	X	X	X
B	X	X	X
C	X		X
D	X		X

A	Inspection after an intervention with possible effects on the mechanical strength or after use change or in case the machine has not been working for more than two years. Replace all the components which are not suitable any more. Do not carry out checks at a higher pressure than the one indicated in the project.
B	Inspection after a repair, or significant adjustment of the system, or its components. The check may be limited to the interested parts, but if a leakage of refrigerant is detected, a leakage search must be carried out on the entire system.
C	Inspection after installation in a different position than the original one. Refer to point A when mechanical strength could have been affected by the change.
D	Leak search, following a well-founded suspicion of refrigerant leakage. It is recommended to examine the system for leakage, either directly (use of leak detection systems) or indirectly (deduction of leakage based on analysis of operating parameters), focusing on the parts most prone to leakage (e.g. joints).



If a defect is detected that compromises the reliable operation of the unit, the unit cannot be re-started until it has been repaired.

7.4 Periodical checks



The start-up operations should be performed in compliance with all requirements of the previous paragraphs.



All of the operations described in this chapter **MUST BE PERFORMED BY TRAINED PERSONNEL ONLY**. Before commencing service work on the unit ensure that the electric supply is disconnected. The top case and discharge line of compressor are usually at high temperature. Care must be taken when working in their surroundings. Aluminium coil fins are very sharp and can cause serious wounds. Care must be taken when working in their surroundings. After servicing, replace the cover panels, fixing them with locking screws.

7.4.1 Electrical system and adjustment

Action to be performed	Frequency					
	Monthly	Every 2 months	Every 6 months	Every year	Every 5 years	As necessary
Check that the unit works properly and that there are no active warnings	X					
Visually inspect the unit	X					
Check noise and vibration level of the unit				X		
Check operation of safety features and of interlocks				X		
Check the unit's performance				X		
Check the current draws of the different parts (compressors, fans, pumps, etc.)				X		
Check the supply voltage of the unit			X			
Check tightness of cables in their clamps			X			
Check the integrity of the insulating coating of power cables				X		
Check the conditions and functioning of the counters				X		
Check functioning of the microprocessor and of the display			X			
Clean the electrical and electronic components of any dust				X		
Check functioning and calibration of probes and transducers				X		

7.4.2 Condensing coils and fans

Action to be performed	Frequency					
	Monthly	Every 2 months	Every 6 months	Every year	Every 5 years	As necessary
Visually inspect the coil	X					
Clean finned coils ⁽¹⁾			X			
Check the water flow and/or any leaks	X					
Check that the flow switch is working properly			X			
Clean the metal filter on the water line ⁽³⁾			X			
Check noise and vibration level of the fans				X		
Check the supply voltage of the fans			X			
Check the fans' electrical connections				X		
Check functioning and calibration of the fans' speed adjustment system (if present)				X		
Check 4-way valve operation (if present)				X		
Check air presence in the hydraulic circuit	X					
Check color of moisture indicator on liquid line				X		
Check for freon leaks ⁽²⁾						X



⁽¹⁾ If the unit is installed in strongly windy areas, near coasts or deserts or in areas subjects to wind and/or sand storms, or near airports, industries or in places with high levels of air pollution in general inspect the unit more frequently (every three months or more) to check the real condition of the surface protection.



⁽²⁾ In order to carry out operations on the refrigerant, it is necessary to observe the European Regulation 517_2014, "Obligations regarding the containment, use, recovery and destruction of fluorinated greenhouse gases used in stationary refrigeration, air conditioning and heat pump equipment".



⁽³⁾ It can be carried out with a higher frequency (also weekly) depending on the Δt .

7.4.3 Compressors

Action to be performed	Frequency					
	Monthly	Every 2 months	Every 6 months	Every year	Every 5 years	As necessary
Visually inspect compressors				X		
Check noise and vibration level of the compressors				X		
Check the supply voltage of the compressors			X			
Check the compressors' electrical connections				X		
Check the oil level in the compressors by checking the oil level light.			X			
Check that the crankcase heaters are powered and working properly				X		
Check the conditions of the compressors' power cables and their tightness in the clamps			X			



Daily and monthly works may be carried out directly by the Owner of the system. All other works must be performed by authorised and trained personnel.



Any kind of cleaning whatsoever is forbidden before disconnecting the device from power supply by turning the master switch to the OFF position. It is forbidden to touch the device while barefooted or with wet or damp body parts.



Works on the cooling line must be carried out by qualified and trained technicians, as provided by local laws and regulations in force.



Before the start-up it is necessary to carry out all the operations described in the previous tables and make the necessary checks provided by the pre-start control module (valid for the Italian market) to be requested to the service.

7.4 Refrigerant circuit repair



If the refrigerant circuit is to be emptied, all the refrigerant must be recovered using the correct equipment.

For leak detection, the system should be charged with nitrogen using a gas bottle with a pressure reducing valve, until 15 bar pressure is reached. Any leakage is detected using a bubble leak finder. If bubbles appear discharge the nitrogen from the circuit before brazing using the proper alloys.



Never use oxygen instead of nitrogen: explosions may occur.

Site assembled refrigerant circuits must be assembled and maintained carefully, in order to prevent malfunctions.

Therefore:

- Avoid oil replenishment with products that are different from that specified and that are pre-loaded into the compressor.
- In the event of a gas leakage on machines using refrigerant R407C, even if it is only a partial leak, do not top up. The entire charge must be recovered, the leak repaired and a new refrigerant charge weighed in to the circuit.
- When replacing any part of the refrigerant circuit, do not leave it exposed for more than 15 minutes.
- It is important when replacing a compressor that the task be completed within the time specified above after removing the rubber sealing caps.
- When replacing the compressor following a burn out, it is advisable to wash the cooling system with appropriate products including a filter for acid.
- When under vacuum do not switch on the compressor.

8. DECOMMISSIONING

8.1 Disconnect the unit



All decommissioning operations must be performed by authorized personnel in accordance with the national legislation in force in the country where the unit is located.

- Avoid spills or leaks into the environment.
- Before disconnecting the machine please recover:
 - the refrigerant gas;
 - Glycol mixture in the hydraulic circuit;
 - the compressor lubricating oil.

Before decommissioning the machine can be stored outdoors, providing that it has the electrical box, refrigerant circuit and hydraulic circuit intact and closed.

8.2 Disposal, recovery and recycling

The frame and components, if unusable, should be taken apart and sorted by type, especially copper and aluminum that are present in large quantities in the machine.

All materials must be recovered or disposed in accordance with national regulations.

8.3 RAEE Directive (only UE)



The crossed-out bin symbol on the label indicates that the product complies with regulations on waste electrical and electronic equipment.

The abandonment of the equipment in the environment or its illegal disposal is punishable by law.

This product is included in the application of Directive 2012/19/EU on the management of waste electrical and electronic equipment (WEEE).

The unit should not be treated with household waste as it is made of different materials that can be recycled at the appropriate facilities. Inform through the municipal authority about the location of the ecological platforms that can receive the product for disposal and its subsequent proper recycling.

The product is not potentially dangerous for human health and the environment, as it does not contain dangerous substances as per Directive 2011/65/EU (RoHS), but if abandoned in the environment it has a negative impact on the ecosystem.

Read the instructions carefully before using the unit for the first time. It is recommended not to use the product for any purpose other than that for which it was designed, as there is a risk of electric shock if used improperly.

9. DIAGNOSIS AND TROUBLESHOOTING

9.1 Fault finding

All units are checked and tested at the factory before shipment, however, during operation an anomaly or failure can occur.



BE SURE TO RESET AN ALARM ONLY AFTER YOU HAVE REMOVED THE CAUSE OF THE FAULT; REPEATED RESET MAY RESULT IN IRREVOCABLE DAMAGE TO THE UNIT.

Code	Alarm Description	Cause	Solution
ACF1	Configuration alarm	Wrong configuration of microprocessor control system.	Contact the company.
ACF2	Configuration alarm		
ACF3	Configuration alarm		
ACF4	Configuration alarm		
ACF5	Configuration alarm		
ACF6	Configuration alarm		
ACF7	Configuration alarm		
ACF8	Configuration alarm		
ACF9	Configuration alarm		
ACFL	Source side water flowswitch	Check the source side water system or clean the water filter	Check the source side water system or clean the water filter
AEE	Eeprom alarm	Severe hardware damage in the microprocessor control system.	Switch OFF the unit and, after few second switch ON the unit; if the alarm appears again contact the service.
AEFL	User water flow switch alarm	Presence of air or dirtiness in the user hydraulic system.	Bleed carefully the user hydraulic system or check and clean the water strainer.
AEU _n	Compressor unloading alarm (only units with 2 compressors)	User water temperature is too high.	Wait until the user water temperature is lower.
AP1	Alarm user inlet water temperature sensor	Wrong electrical connection, Sensor defect.	Check the electrical connection of the sensor to the terminal board, if correct call the service to replace the sensor.
AP10	Alarm safety domestic hot water sensor		
AP2	Alarm user outlet water temperature sensor		
AP3	Alarm pressure transducer		
AP4	Alarm finned coil sensor / defrost sensor		
AP5	Alarm domestic hot water inlet temperature sensor		
AP6	Alarm domestic hot water outlet temperature sensor		

AP7	Alarm ambient sensor	Wrong electrical connection, Sensor defect.	Check the electrical connection of the sensor to the terminal board, if correct call the service to replace the sensor.
AP8	Not used		
AP9	Not used		
AtE1	Evaporator water pump 1 overload		
AtE2	Evaporator water pump 2 overload		
B1 HP	High pressure switch circuit 1	<p>In heating mode: Insufficient user circuit water flow; Insufficient domestic hot water circuit water flow.</p> <p>In cooling mode: Insufficient air flow at the source fan; Insufficient domestic hot water circuit water flow.</p>	<p>Restore the correct user circuit water flow. Restore the correct domestic hot water circuit water flow.</p> <p>Restore the correct air flow to source fan. Restore the correct domestic hot water circuit water flow.</p>
b1AC	Anti-freeze alarm circuit 1 (cooling mode)	Too low water temperature	Check user temperature set point; Check user water flow.
b1AH	Anti-freeze alarm circuit 1 (heating mode)	Too low water temperature	Check user temperature set point.
b1dF	Wrong defrost circuit 1 (maximum time admitted)	Defrost time too long; Outside temperature outside the working limits; Refrigerant charge leakage.	Check defrost set point; Restore normal working conditions; Find leakage and repair.
b1hP	High pressure transducer alarm circuit 1	Transducer defect	Replace the faulty transducer.
B1LP	Low pressure switch circuit 1	Refrigerant charge leakage.	Find leakage and repair.
b1IP	Low pressure transducer alarm circuit 1	Transducer defect	Replace the faulty transducer.
b1tF	Overload source fan alarm	Fan input current outside operation limits.	Check the proper operation of the source fan and, in case replace it.
C1tr	Compressor 1 overload	Compressor 1 input current outside operation limits.	Replace the compressor.
C2tr	Compressor 2 overload	Compressor 1 input current outside operation limits.	Replace the compressor.



Technical data shown in this booklet are not binding.
The Company shall have the right to introduce at any time whatever modifications necessary to the improvement of the product.
The reference languages for the whole documentation are Italian and English. The other languages are to be considered only as guidelines.
